

m  
Materasso

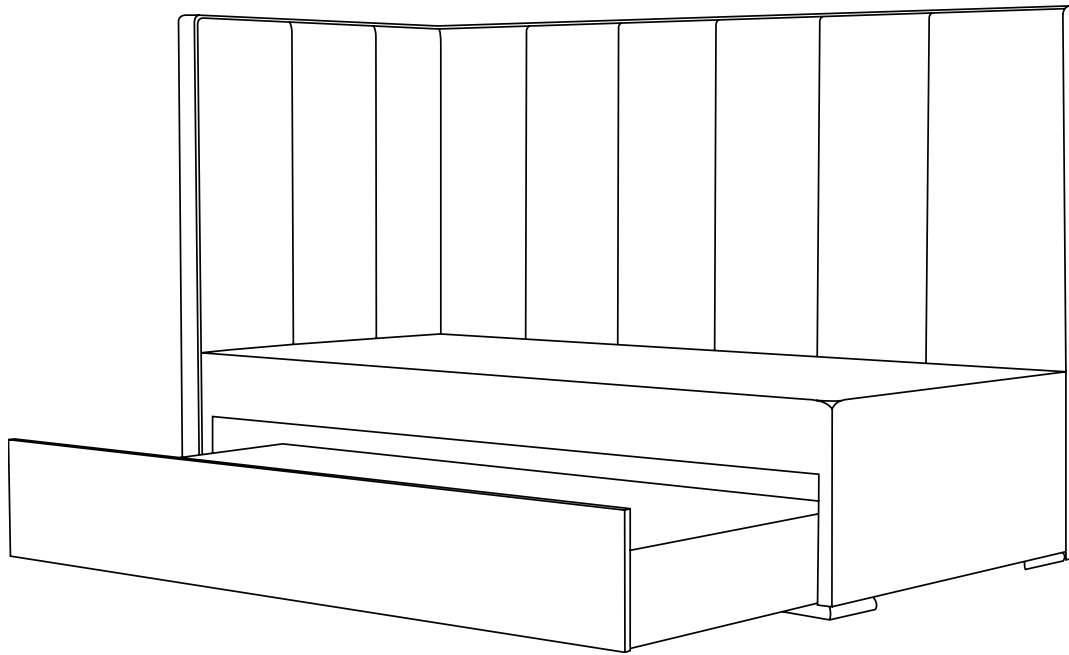

CZ

**m**  
**Materasso**  
*Pro chvíle, na kterých záleží...*



- 15 DAMIANI SET
- 17 CRISTAL SET
- 19 SPECTRA SET
- 21 CORONA SET
- 23 FRANCESCA LUX SET
- 25 SOUL SET

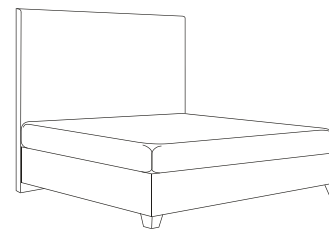

- 27 CHESS
- 29 ZINA
- 31 DUNA
- 33 CRISTAL
- 35 LA SPEZIA
- 37 DAMIANI
- 39 SOUL
- 41 CORIUM
- 43 FORREST
- 45 CHESTERFIELD
- 47 RHOMBUS
- 49 WILD
- 51 KINGSTONE
- 53 HONEY
- 54 MELVA
- 56 SPECTRA

- 58 HORIZONTAL
- 60 NAVY
- 62 ENIF
- 64 GEMINI
- 67 FRANCESCA LUX
- 69 CLAUDIA LUX
- 70 ALESIA
- 73 VEGA
- 75 BELLATRIX
- 76 ATLAS
- 78 CORONA
- 80 PARIS
- 82 VIENNA
- 84 NOBILIA
- 87 ARGENTINA
- 89 SIRIUS
- 91 VELORUM
- 93 CORIUM SLIDE
- 95 WALL
- 97 TWINS

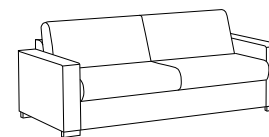

- 99 AMIRA
- 101 SIESTA
- 103 SOFABED BARI
- 105 SOFABED TORVI
- 107 SOFABED SINGLE
- 109 SOFABED DOUBLE

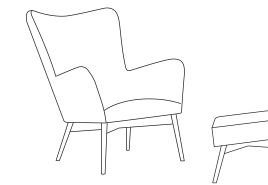

- 110 BOUDOIR MONT BLANC
- 111 MONT BLANC
- 112 BOSS
- 113 MOON
- 114 PUFF
- 116 BOUDOIR BREEZE
- 117 BREEZE
- 118 DE LUXE
- 119 MODERN
- 120 CUT
- 120 CASTELO
- 120 CROSS

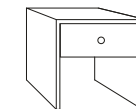

- 121 INDUSTRY
- 121 HEAVY OAK
- 121 OAK
- 122 WHITE
- 122 STONE
- 122 DARK STONE
- 123 CUBE
- 123 DAMIANI
- 123 BIANCA
- 124 TABURET | BENCH



Společnost Materasso s. r. o. je rodinná firma, která je na trhu již více než 30 let.

Na českém i evropském trhu a v posledních letech i na trzích mimoevropských je známá výrobou certifikovaných zdravotních matrací, designových postelí, interiérových doplňků (taburety, křesla, noční stolky...) a postelových doplňků (přikrývky, polštáře, matracové chrániče).

Díky neustále se rozrůstajícímu sortimentu našich výrobků, použití kvalitních materiálů, dodržování certifikovaných výrobních postupů a následnému servisu rozšiřujeme řady spokojených zákazníků - a to běžných klientů i profesionálů (interiérových designérů nebo hoteliérů).

Ložnice je nejdůležitějším a nejméně známým místem ve Vaší domácnosti.

Je to místo odpočinku a relaxace těla i všech smyslů po celodenní námaze. Tam získáváte sílu a připravujete se na nové výzvy.

Uvědomujeme si, že ústředním bodem ložnice je postel, která jí dává duši i charakter. Proto kolekci našich postelí charakterizuje nejen pevná konstrukce a perfektní vypracování, ale zároveň i krásný design, bohatý výběr potahových látek a jejich barevného provedení.

Ve spojení s nabídkou našich zdravotních matrací Vám poskytneme komfort a pohodlí té nejvyšší úrovně. Velký důraz klademe na funkčnost a možnost vytvoření modelů postelí přesně podle Vašich představ.

Díky velkému množství variací v nabídce tvarů a designů, také barev a doplňkových funkcí, určitě najdete v naší nabídce postel, kterou dotvoříte styl Vašeho interiéru tak, aby se ložnice stala nejužitečnějším místem ve Vašem domě.

Stavíme na silném týmu kvalifikovaných odborníků s dlouholetými zkušenostmi v oblasti výroby ortopedických matrací a postelí a zároveň na kvalitě našich výrobků.

Nabízíme možnost kombinace různých spacích systémů s bohatým výběrem moderních čel postelí, v různých designech a způsobech spracování. Vyrábíme různé typy korpusů postelí s užšími nebo silnějšími bočnicemi, postele ve standardní i atypické délce, v pohodlných boxspringových verzích známých především z hotelů.

Zákazník si může zvolit verzi bez nebo s úložným prostorem. Individuální je i výběr roštů od klasických pevných, s výklapem nebo s elektrickým pohonem polohování.

Neustále sledujeme nové technologie a trendy v interiérovém designu. Jejich následná aplikace do výroby nám umožnila vytvořit ucelenou a designově zdařilou kolekci postelí i celých ložnicových setů. Design a styl postelí je umocněn použitím kvalitních čalounických potahových látek. V naší nabídce najdete nejen látky s originálními vzory a strukturami, ale také látky se speciální úpravou pro snadné čištění, látky odolávající absorpci tekutin a nečistot. Každou postel z nabídky (v jakémkoliv provedení korpusu), je možné doladit vhodným výběrem nožiček v rozmanitých provedeních ať už jde o materiál, tvar nebo výšku.



Možnosti uložení matrace:

## 1. SYSTÉM SE ZAPUŠTĚNÍM MATRACE:

Matrace je zapuštěná do rámu postele, což znamená, že vnější rozměr postele je větší než rozměr matrace.

Tento způsob je možný pouze u rámových postelí.



## 2. SYSTÉM CORIUM:

Matrace je položena na spací systém (rámová postel nebo boxspring), přičemž vnější rozměry matrace jsou totožné s rozměry spacího systému postele.

## POSTELOVÉ SYSTÉMY

Každý postelový systém je možné kombinovat s libovolným čelem postele a nožičkami. Můžete si vybrat z velké nabídky kvalitních čalounických látek.

Ke každé posteli je možné objednat i taburet, křeslo nebo podnožku ke křeslu ve stejné látce.

Výšky spacích systémů jsou uvedeny bez nožiček. Všechny postele v rámci dětského a teenager programu vyrábíme už od šířky 90 cm.

Celý korpus postele (bez čela a roštů) je balený v kartónové krabici, což zjednodušuje přepravu a zlepšuje ochranu při manipulaci.

Ve všech montovaných spojích u rámových korpusů jsou použity matice a šrouby s metrickým závitem, umožňující i opětovnou bezproblémovou montáž.

## POUŽITÉ ZKRATKY

UP – úložný prostor  
BV – boční výklop  
NV – nožní výklop

NEW



## BOXSPRING SLIDE

Boxspring je navržen s ohledem na maximální komfort a funkčnost. Díky kombinaci taštičkové pružiny a vrstvy PUR 35 ve vrchní části boxspringu poskytuje optimální pohodlí pro spaní. Tato kombinace zajišťuje dostatečnou oporu těla a současně pružnost, která přispívá k relaxačnímu a zdravému spánku.

Tento boxspring je ideální volbou pro ty, kteří ocení praktičnost zakomponované extra přistýlky bez kompromisů v pohodlí. Lineární výsuvná kování umožňují snadnou a plynulou manipulaci. Matraci přistýlky si můžete vybrat dle vlastních preferencí, přičemž maximální výška matrace je 20 cm.

NEW



## HIGHLIGHT

Box je čalouněný ve stejné látce jako čelo postele a na ložné ploše boxspringu je speciální potahová látka s úpravou ANTISLIP, která dokonale fixuje matraci proti posunu.

Výška bočnice boxu je 10 cm.



### BOXSPRING 22-32 CM

Je nejpokrokovější postelový systémem. Jeho oblíbenost je dána specifickou konstrukcí: masivní rám boxspringu obklopuje pružinovou kostru, která zajišťuje bodově přizpůsobivý podklad pod matrací, zlepšuje kopírovací vlastnosti a celkovou přizpůsobivost použité matrace. Takové složení vytváří výjimečný systém dvojího kopírování přirozeného tvaru těla.

Boxspring je čalouněný ve stejné látce jako čelo postele a na ložné ploše boxspringu je speciální potahová látka s úpravou ANTISLIP dokonale fixující matraci proti posunu. Výška bočnice boxspringu je 22 nebo 32 cm. Matrace není zapuštěná do rámu postele, ale lícuje s boxspringem.



### BOXSPRING UP VÝKLOP MAXI

UP MAXI 40, UP MAXI 100 a taky UP MAXI electric je ideálním řešením pro všechny, kteří hledají komfortní postel s přednostmi boxspringu, která je doplněna o velký úložný prostor uvnitř postele. Boxspringová konstrukce zmenšuje požadavky na prostor v ložnici a dovoluje použít i rozměrově větší matraci oproti tradičnímu typu postele.

Úložný prostor bez vnitřních dělících příček poskytuje výjimečně velký prostor s výborným přístupem po celé ploše. Boxspring UP MAXI 40 bude bez problémů zvedat matraci do celkové hmotnosti 40 kg. Pro matrace s vyšší hmotností je určen systém UP MAXI 100. Ten disponuje 4 ks kování a pístů pro snadné zvedání víka úložného prostoru spolu s těžkými matracemi. Zvedání víka u UP MAXI ELECTRIC zajišťuje elektrický mechanismus. Výška boxspringu je 32 cm.



### UP WOOD

Je určen pro ty, kteří potřebují více úložného prostoru v ložnici a také upřednostňují jednu společnou partnerskou matraci. Rám postele má tloušťku 5 nebo 8 cm, a výšku 30 nebo 35 cm.

Vybaven je konstrukcí a roštem z masivního bukového dřeva. Rošt se z přední části postele vyklápí pomocí kování s pneumatickými písty, které usnadňují přístup do úložného prostoru i při použití těžkých matrací.



### UP METAL

Je určena pro ty, kteří potřebují více úložného prostoru v ložnici a také upřednostňují jednu společnou partnerskou matraci.

Rám postele má 5 nebo 8 cm tloušťku, 30 nebo 35 cm výšku.

Vybaven je speciálním roštem s kovovou konstrukcí, který se z přední části postele vyklápí pomocí kování s pneumatickými písty, které usnadňují přístup do úložného prostoru i při použití těžkých matrací. Kovový rám roštu je osazen předpjatými lamelami. Demontáží dna v úložném prostoru získáme přístup pod celou plochou postele, což oceníte především při úklidu.





### UP METAL LIFT-UP

Vylepšením UP metal je METAL LIFT-UP, usnadňující přístup do úložného prostoru v oblasti čela postele a také velmi zjednodušuje výměnu ložního prádla.



### UP BV | UP NV

Designová postel UP BV a UP NV (s polohováním hlavy), s použitím dřevěných výklopných roštů. Pro tuto postel je vhodné použít dvě samostatné matrace, aby bylo možné plnohodnotně využívat výklopné rošty.

Matrace při použití roštů METAL, DOBLE NV a DOBLE BV je zapuštěna 6 cm od vrchní hrany bočnice.

V provedení Corium lze rošt METAL namontovat ve výšce boční hrany bočnice a matrace je uložena i na roštu, i na bočnicích. Taková postel bude působit dojmem boxspringu a šířka postele (včetně bočnic) bude stejná s šířkou matrace.



### BEZ ULOŽNÉHO PROSTORU

Designová postel je určena pro ty, kteří nepotřebují úložný prostor v posteli. Rám postele je podobný jako postelí s UP, neobsahuje však upevnění pro dno úložného prostoru.

V tomto rámu je možné použít všechny typy roštů pod matraci: od jednoduchých masivních laťových roštů, přes laťové masivní v rámu, pružné lamelové, polohovatelné, až po modely s plynulým elektrickým polohováním. pro absolutní pohodlí během spánku, ale i pro chvíle aktivního odpočinku, např. při čtení. Korpusy vyrábíme ve dvou různých tloušťkách panelů: 5 nebo 8 cm a třech výškách: 15, 30 nebo 35 cm.



### BOXSPRING MOBIL

Konstrukce postele je shodná s boxspringem 22/32 a je doplněna o funkci plynulého polohování hlavy, zádové části a nohou pomocí elektromotoru s ovládačem. Tento typ postelí nemá vystupující bočnice a polohování umožňuje nastavení nejlepší pozice pro odpočinek. Jiná je poloha pro spaní, jiná pro aktivní odpočinek (např. čtení), jiná při regeneraci bolavých nohou.

Boxspring Mobil ideálně spolupracuje s matracemi ze studených pěn, s anatomicky prořezanými jádry, latexovými matracemi a také matracemi z „líných“ termoelastických pěn.

Tyto matrace přesně kopírují tvar roštu při polohování. Výška boxspringu je 32 cm.

## SETY POSTELÍ, ČALOUNĚNÍ STĚN A DOPLNKŮ

Novinka, která je velmi vítaná nejen ze strany interiérových designérů a hoteliérů, ale stále více i běžných spotřebitelů, je možnost si z naší nabídky ke každé posteli objednat i taburet, noční stolky, křeslo nebo podnožku ke křeslu ve stejné čalounické látce jako je látka postele.

Pro ty, kteří již mají vlastní kvalitní postel (např. z masivu) a plánují povznést interiér své ložnice, nabízíme možnost kombinovat ve stejné čalounické látce jednotlivé interiérové doplňky navzájem nebo spolu s některým z variant pro čalounění stěny za čelem postele. SET (kombinace) postele a některého nebo všech ze zmíněných interiérových doplňků v identické čalounické látce umocňuje celkový dojem z Vaší ložnice, navozuje žádaný konečný pocit elegance a luxusu a je odrazem Vašeho jedinečného vkusu a preferencí.







# DAMIANI SET

NEW

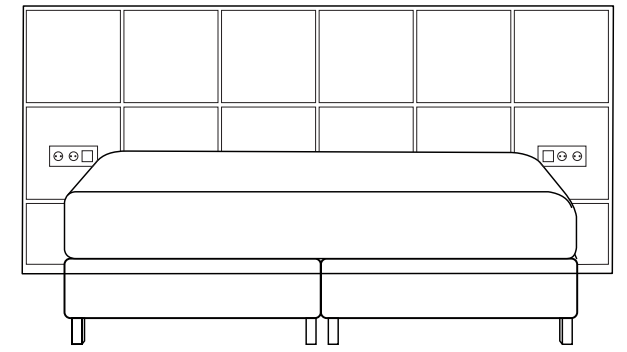

DAMIANI  
(p. 37)

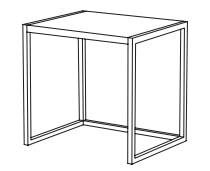
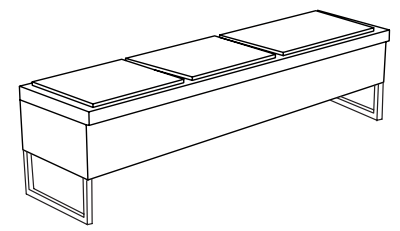

DAMIANI  
(p. 123)





# CRISTAL SET

NEW

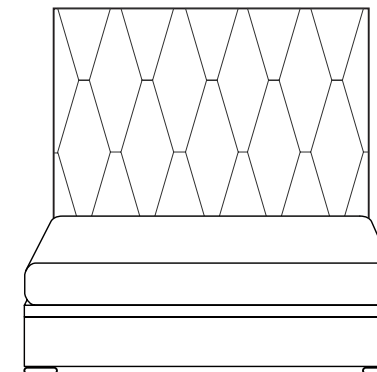

**CRISTAL**  
(p. 33)

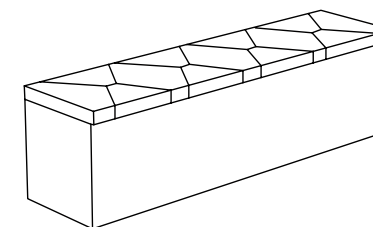

**TABURET**  
No. 5 (p. 125)

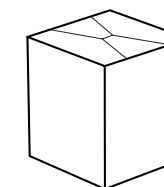

**CUBE - CRISTAL**  
(p. 123)



# SPECTRA SET

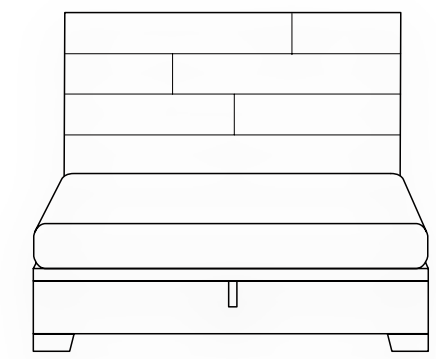

**SPECTRA**  
(p. 56)

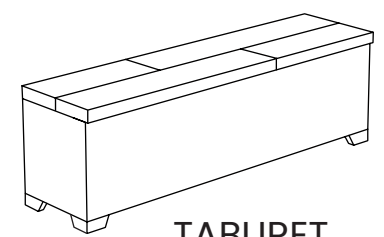

**TABURET**  
No. 7 (p. 125)



**BIANCA**  
(p. 123)

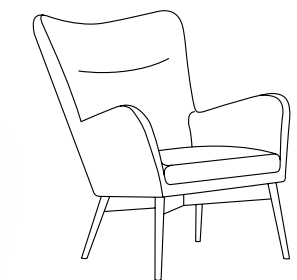

**BREEZE**  
(p. 117)

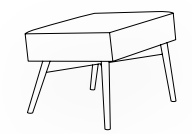

**CUT**  
(p. 120)





# CORONA SET

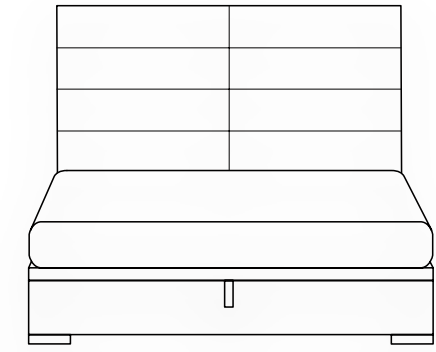

**CORONA**  
(p. 78)

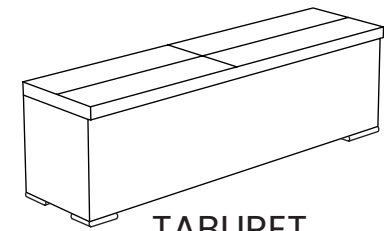

**TABURET**  
No. 4 (p. 125)

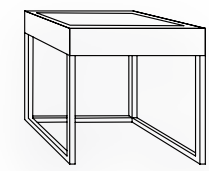

**INDUSTRY**  
(p. 121)

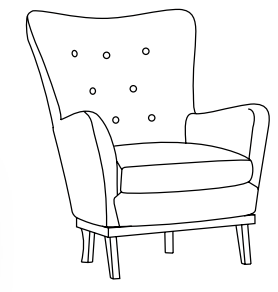

**DE LUXE**  
(p. 118)

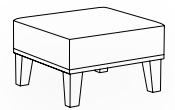

**CASTELO**  
(p. 120)





# FRANCESCA LUX SET

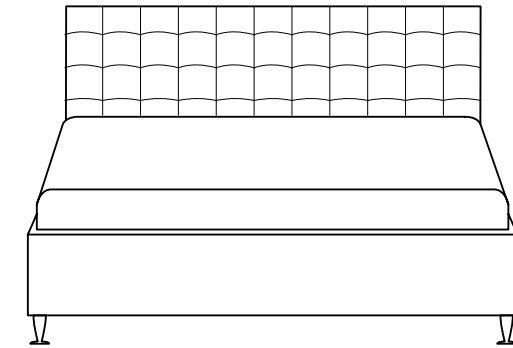

**FRANCESCA LUX**  
(p. 67)

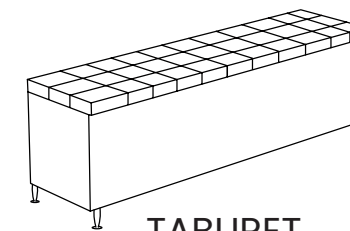

**TABURET**  
No. 12 (p. 125)

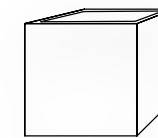

**CUBE**  
(p. 123)

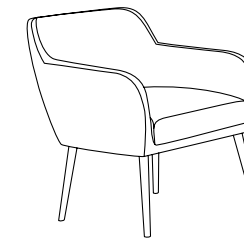

**MODERN**  
(p. 119)



**CROSS**  
(p. 120)





# SOUL SET

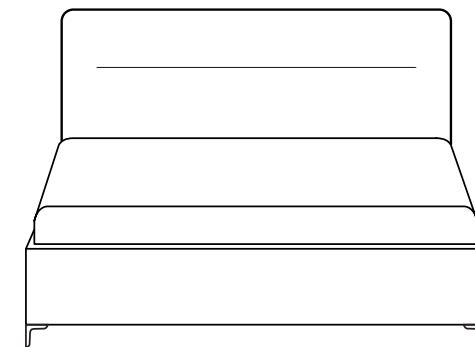

**SOUL**  
(p. 39)

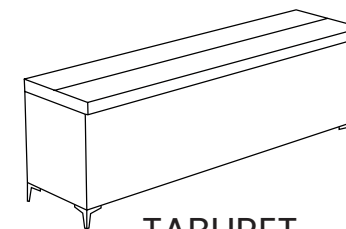

**TABURET**  
No. 1; 3 (p. 125)

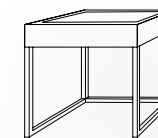

**INDUSTRY**  
(p. 121)

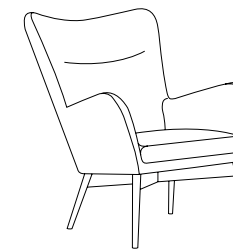

**BREEZE  
MIRACH**  
(p. 117)



**CROSS**  
(p. 120)





# CHESS

NEW

	L	b <sup>l</sup>	b <sup>w</sup>	b <sup>h</sup>	h <sup>w</sup>	h <sup>h</sup>	m <sup>l</sup>	m <sup>w</sup> (cm)
DESING BED	211	205	190	30	270	130	200	180

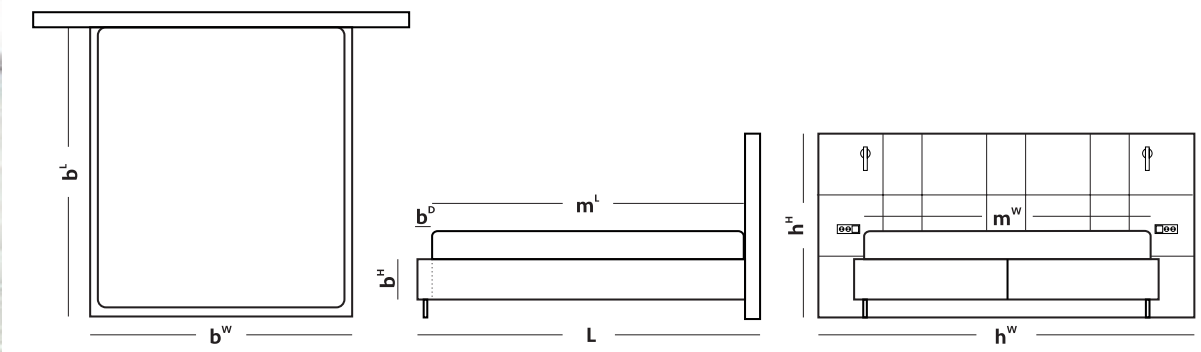



# ZINA

NEW

	L	b <sup>l</sup>	b <sup>w</sup>	b <sup>h</sup>	h <sup>w</sup>	h <sup>h</sup>	m <sup>l</sup>	m <sup>w</sup> (cm)
DESING BED	204	200	180	10	316	139	200	180

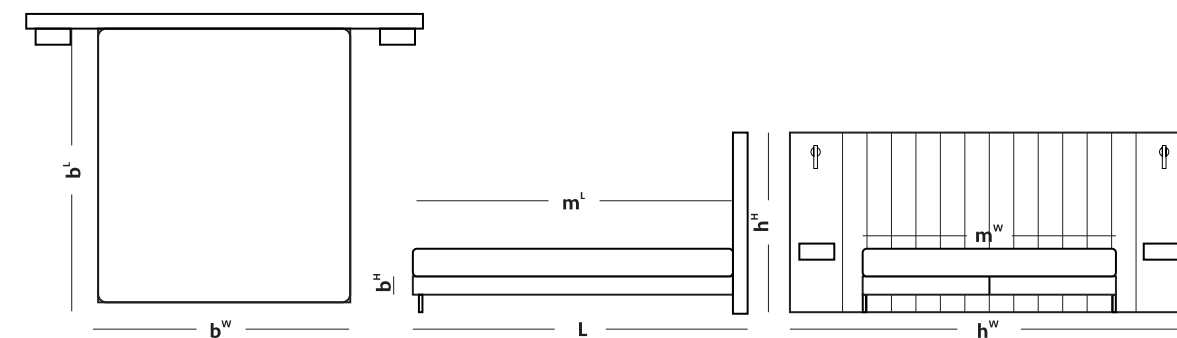





# DUNA

NEW

	L	b <sup>l</sup>	b <sup>w</sup>	b <sup>h</sup>	h <sup>w</sup>	h <sup>h</sup>	m <sup>l</sup>	m <sup>w</sup> (cm)
DESING BED	211	205	190	30	190	111	200	180

Taburet  
(p. 125)

No. 10

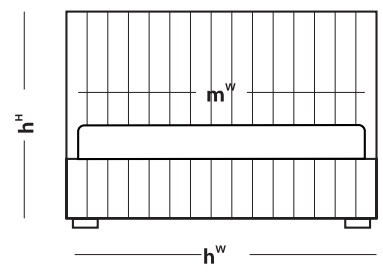
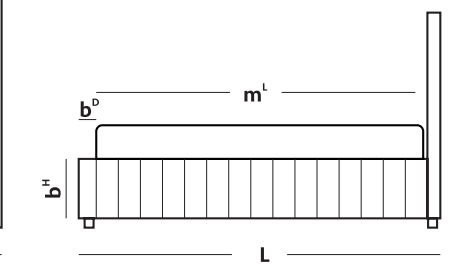
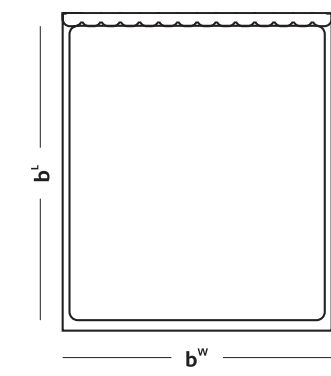
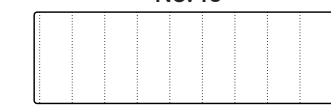





# CRISTAL

	L	b <sup>l</sup>	b <sup>w</sup>	b <sup>h</sup>	h <sup>w</sup>	h <sup>h</sup>	m <sup>l</sup>	m <sup>w</sup> (cm)
Maxi Elektro 32	208	200	180	32	180	160	200	180

Taburet  
(p. 125)

No. 5

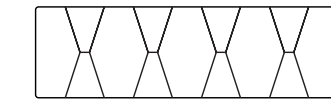

No. 1

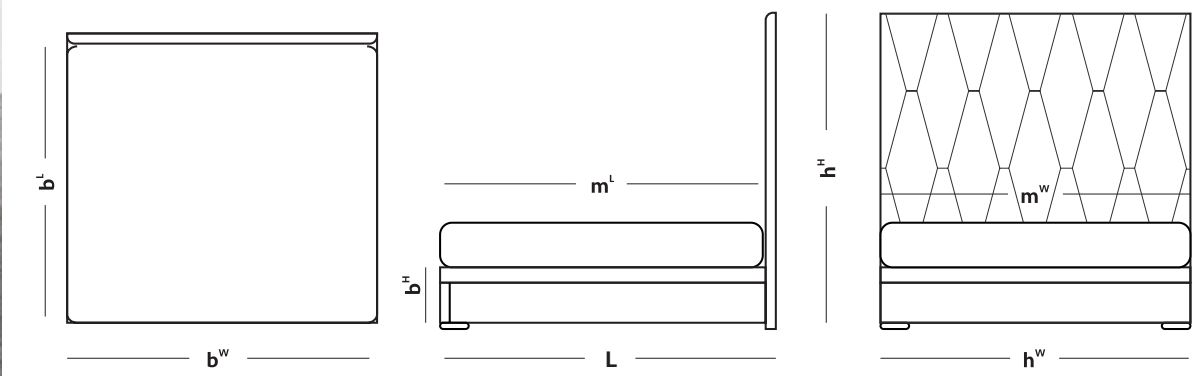





# LA SPEZIA

NEW

	L	b <sup>L</sup>	b <sup>W</sup>	b <sup>H</sup>	h <sup>W</sup>	h <sup>H</sup>	m <sup>L</sup>	m <sup>W</sup> (cm)
DESING BED	213	203	186	35	246	135	200	180

Taburet  
(p. 125)

No. 1

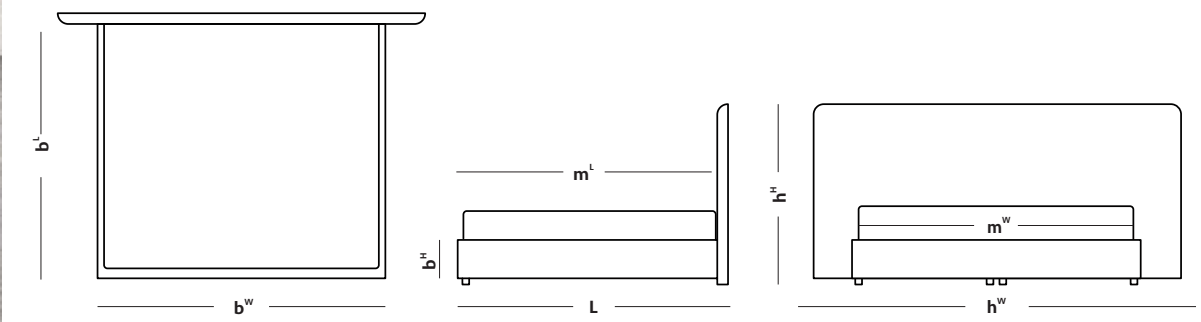



# DAMIANI

NEW

	L	b <sup>L</sup>	b <sup>W</sup>	b <sup>H</sup>	h <sup>W</sup>	h <sup>H</sup>	m <sup>L</sup>	m <sup>W</sup> (cm)
<b>BOXSPRING 22</b>	207	200	180	22	272	122	200	180

Taburet  
(p. 124)

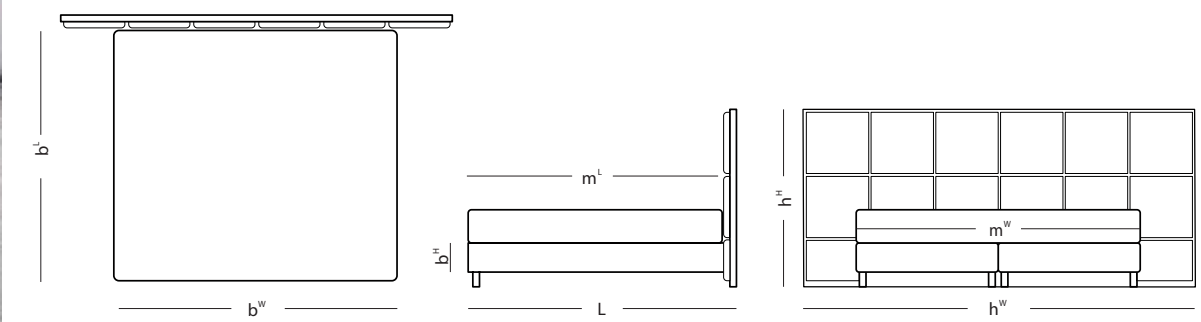
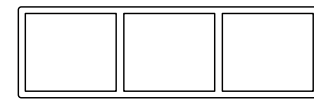





# SOUL

NEW

	L	b <sup>l</sup>	b <sup>w</sup>	b <sup>h</sup>	b <sup>d</sup>	h <sup>w</sup>	h <sup>h</sup>	m <sup>l</sup>	m <sup>w</sup> (cm)
DESING BED	216	205	190	35	5	196	120	200	180
TYPE CORIUM	211	200	180	35	5	186	120	200	180

Taburet  
(p. 125)

No. 1

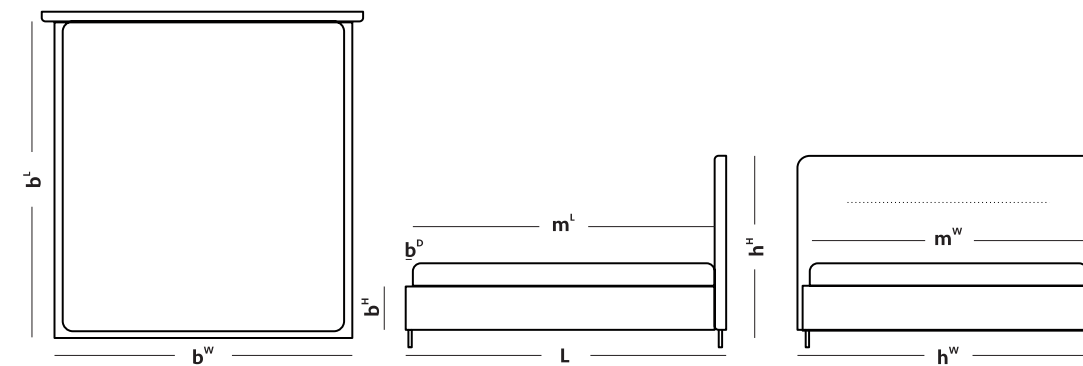





# CORIUM

	L	b <sup>l</sup>	b <sup>w</sup>	b <sup>h</sup>	h <sup>w</sup>	h <sup>h</sup>	m <sup>l</sup>	m <sup>w</sup> (cm)
DESING BED	209	200	180	30	180	150	200	180
CORIUM	209	200	160	30	160	150	200	160

Taburet  
(p. 125)

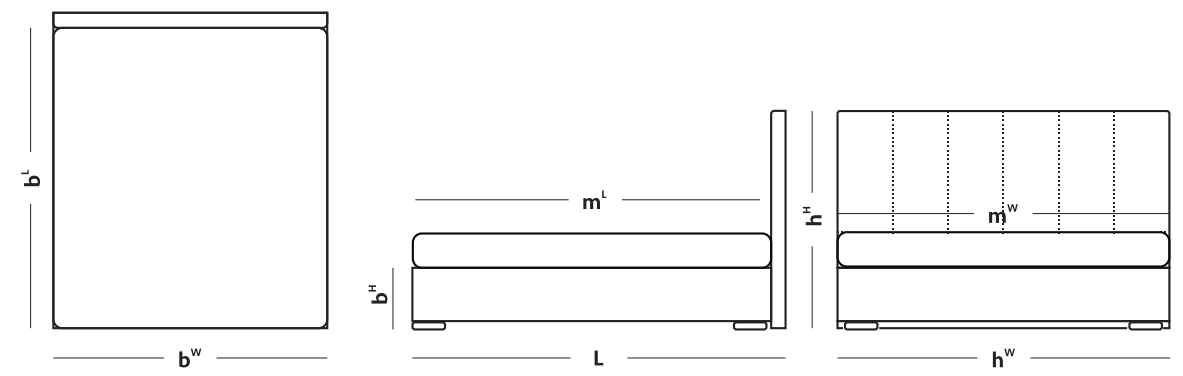
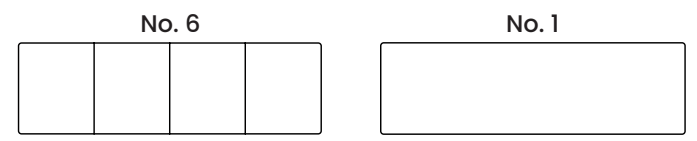





# FORREST

	L	b <sup>l</sup>	b <sup>w</sup>	b <sup>h</sup>	h <sup>w</sup>	h <sup>h</sup>	m <sup>l</sup>	m <sup>w</sup> (cm)
<b>BOXSPRING 32</b>	208	200	180	32	180	160	200	180
	208	200	160	32	160	160	200	160

Taburet  
(p. 125)

No. 1



No. 18

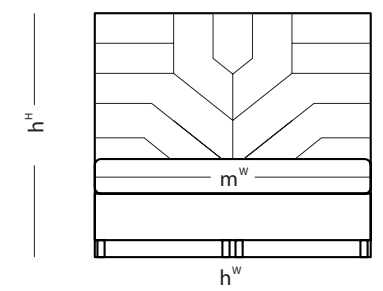
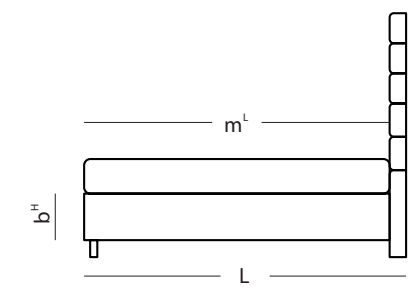
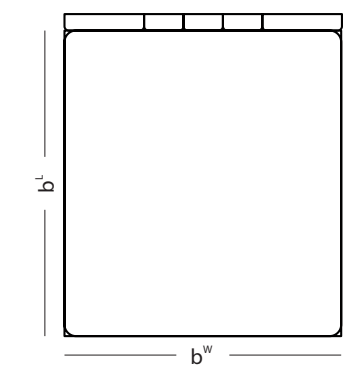



# CHESTERFIELD

	L	b <sup>L</sup>	b <sup>W</sup>	b <sup>H</sup>	h <sup>W</sup>	h <sup>H</sup>	m <sup>L</sup>	m <sup>W</sup> (cm)
<b>BOXSPRING 22</b>	213	200	180	22	180	143	200	180
	213	200	160	22	160	143	200	160

Taburet  
(p. 125)

No. 1

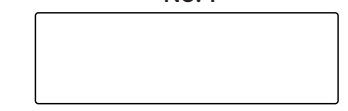

No.17

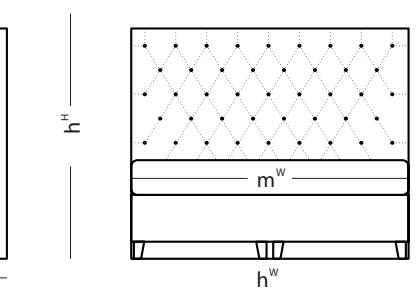
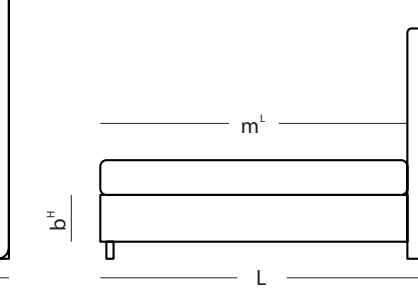
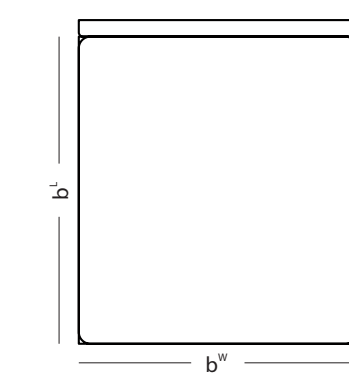
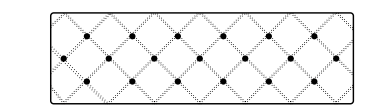





# RHOMBUS

	L	b <sup>L</sup>	b <sup>W</sup>	b <sup>H</sup>	h <sup>W</sup>	h <sup>H</sup>	m <sup>L</sup>	m <sup>W</sup> (cm)
<b>BOXSPRING 32</b>	208	200	180	32	180	160	200	180
	208	200	160	32	160	160	200	160

Taburet  
(p. 125)

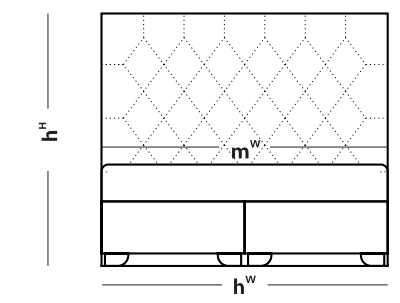
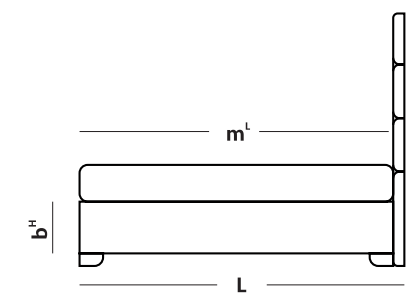
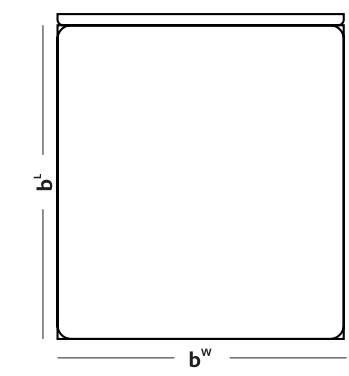
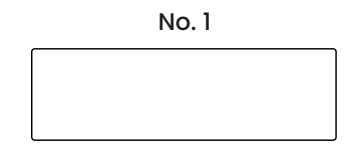
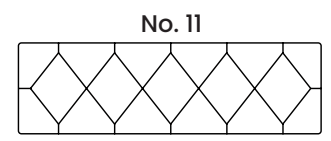





# WILD

	L	b <sup>L</sup>	b <sup>W</sup>	b <sup>H</sup>	h <sup>W</sup>	h <sup>H</sup>	m <sup>L</sup>	m <sup>W</sup> (cm)
<b>BOXSPRING 32</b>	208	200	180	32	180	160	200	180
	208	200	160	32	160	160	200	160

Taburet  
(p. 125)

No. 16



No. 1

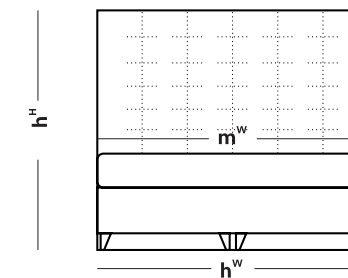
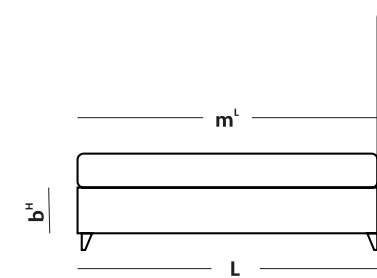
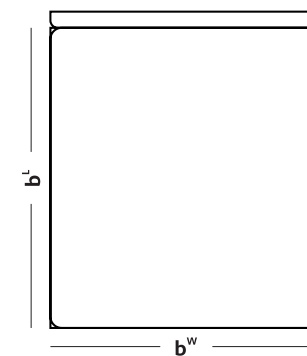





# KINGSTONE

	L	b <sup>L</sup>	b <sup>W</sup>	b <sup>H</sup>	b <sup>D</sup>	h <sup>W</sup>	h <sup>H</sup>	m <sup>L</sup>	m <sup>W</sup> (cm)
DESIGN BED	218	205	190	35	5	190	120	200	180
	218	205	170	35	5	170	120	200	160

Taburet  
(p. 125)

No. 2

No. 1

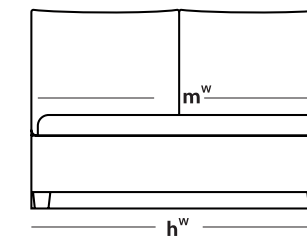
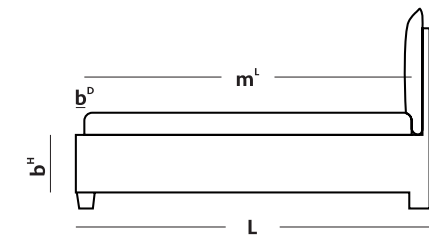
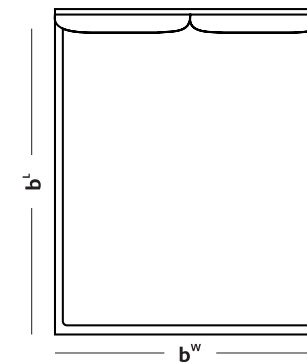



# HONEY

	L	b <sup>L</sup>	b <sup>W</sup>	b <sup>H</sup>	b <sup>D</sup>	h <sup>W</sup>	h <sup>H</sup>	m <sup>L</sup>	m <sup>W</sup> (cm)
DESIGN BED	213	205	190	35	5	190	160	200	180
	213	205	170	35	5	170	160	200	160

Taburet  
(p. 125)

No. 8

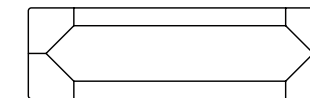

No. 1

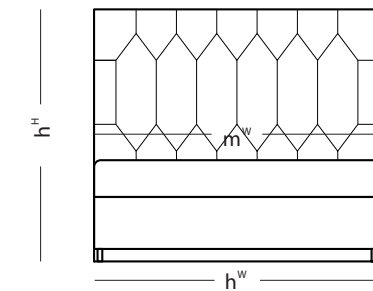
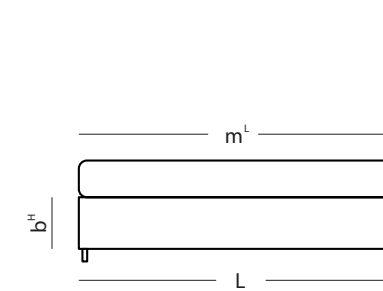
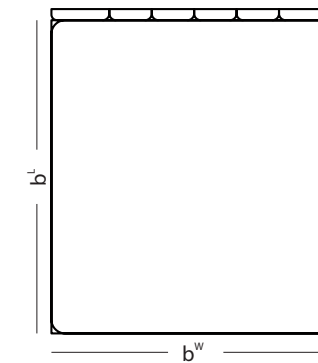



# MELVA

	L	b <sup>l</sup>	b <sup>w</sup>	b <sup>h</sup>	h <sup>w</sup>	h <sup>h</sup>	m <sup>l</sup>	m <sup>w</sup> (cm)
<b>BOXSPRING 32</b>	208	200	180	32	186	160	200	180
	208	200	160	32	166	160	200	160

Taburet  
(p. 125)

No. 13

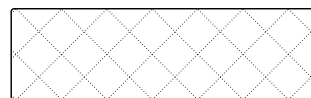

No. 1

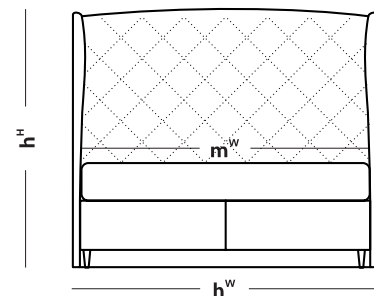
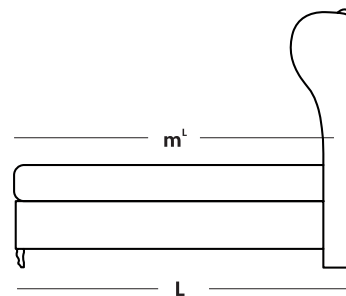
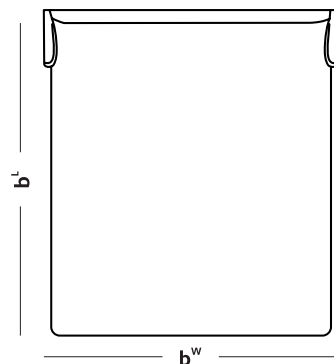



# SPECTRA

	L	b <sup>l</sup>	b <sup>w</sup>	b <sup>h</sup>	h <sup>w</sup>	h <sup>h</sup>	m <sup>l</sup>	m <sup>w</sup> (cm)
MAXI	208	200	180	32	180	130	200	180
	208	200	160	32	160	130	200	160

Taburet  
(p. 125)

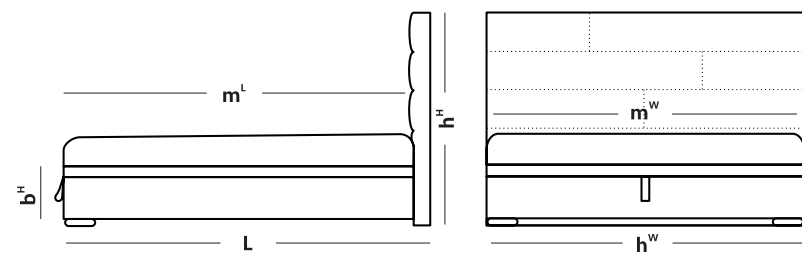
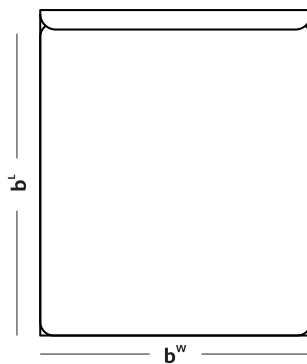
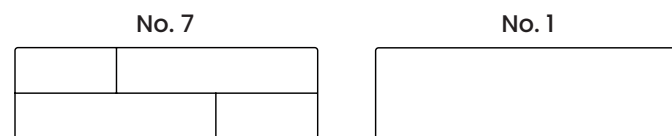



# HORIZONTAL

	L	b <sup>L</sup>	b <sup>W</sup>	b <sup>H</sup>	h <sup>W1</sup>	h <sup>W2</sup>	h <sup>H</sup>	m <sup>L</sup>	m <sup>W</sup> (cm)
<b>MAXI</b>	210	200	180	32	180	240	145	200	180
	210	200	160	32	160	220	145	200	160

Taburet  
(p. 125)

No. 3

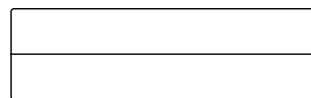

No. 1

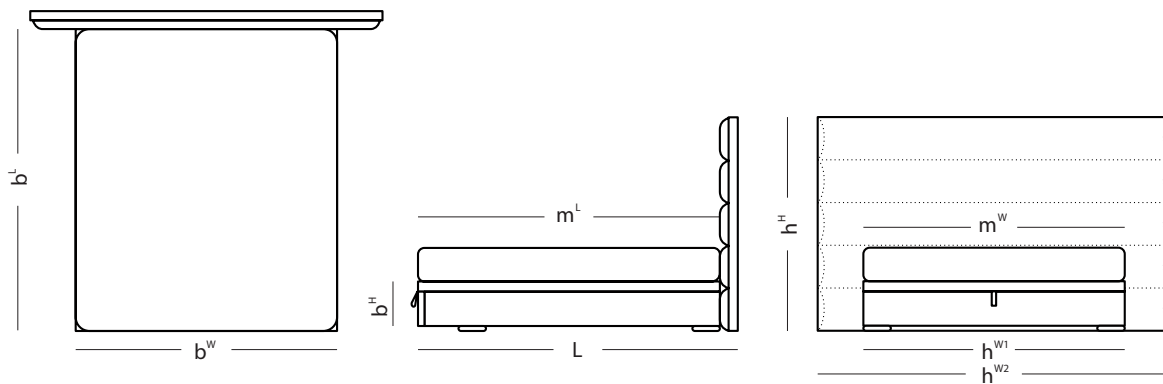

# NAVY

	L	b <sup>L</sup>	b <sup>W</sup>	b <sup>H</sup>	b <sup>D</sup>	h <sup>W</sup>	h <sup>H</sup>	m <sup>L</sup>	m <sup>W</sup> (cm)
DESIGN BED	213	205	190	30	5	190	123	200	180
	213	205	170	30	5	170	123	200	160

Taburet  
(p. 125)

No. 1

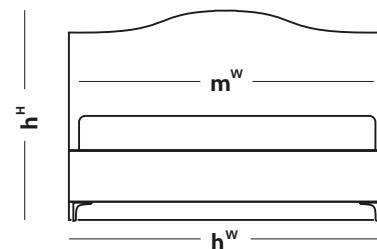
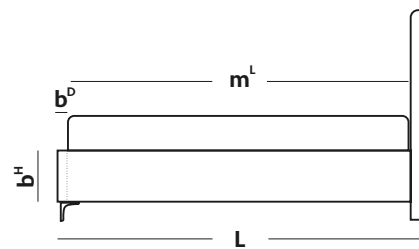
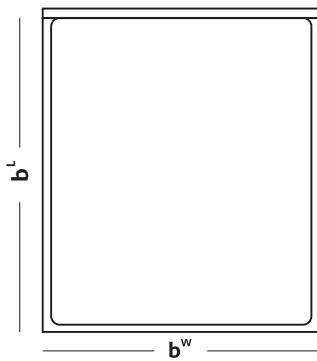



# ENIF

	L	b <sup>L</sup>	b <sup>W</sup>	b <sup>H</sup>	b <sup>P</sup>	h <sup>W</sup>	h <sup>H</sup>	m <sup>L</sup>	m <sup>W</sup> (cm)
DESIGN BED	213	205	190	35	5	196	123	200	180
	213	205	170	35	5	176	123	200	160

Taburet  
(p. 125)

No. 1

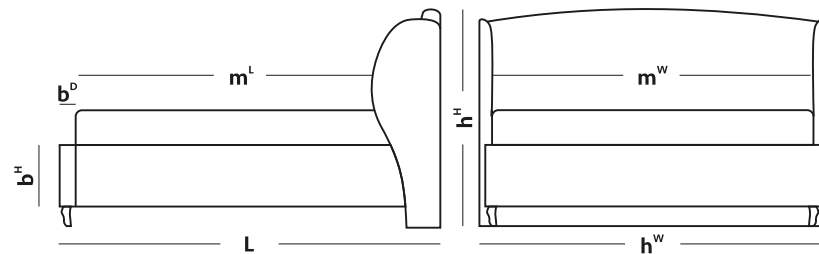
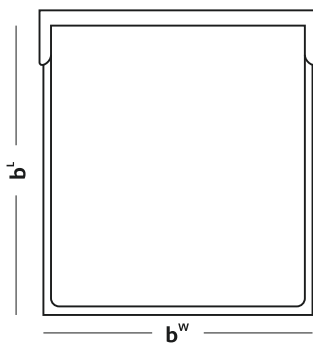



# GEMINI

	L	b <sup>l</sup>	b <sup>w</sup>	b <sup>h</sup>	b <sup>p</sup>	h <sup>w</sup>	h <sup>h</sup>	m <sup>l</sup>	m <sup>w</sup> (cm)
DESIGN BED	213	205	190	30	5	190	150	200	180
	213	205	170	30	5	170	150	200	160

Taburet  
(p. 125)

No. 6

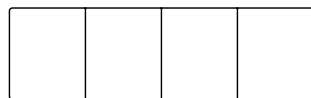

No. 1

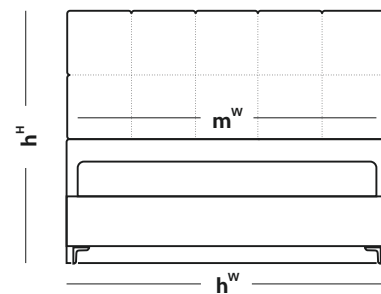
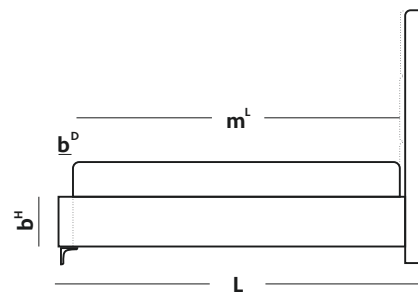
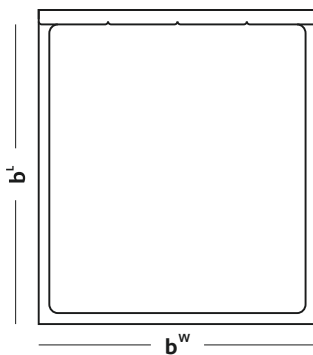





# FRANCESCA LUX

	L1   L2	b <sup>L</sup>	b <sup>W</sup>	b <sup>H</sup>	b <sup>D</sup>	h <sup>W</sup>	h <sup>H</sup>	m <sup>L</sup>	m <sup>W</sup> (cm)
DESIGN BED	231   216	205	190	30	5	190	103	200	180
	231   216	205	170	30	5	170	103	200	160

Taburet  
(p. 125)

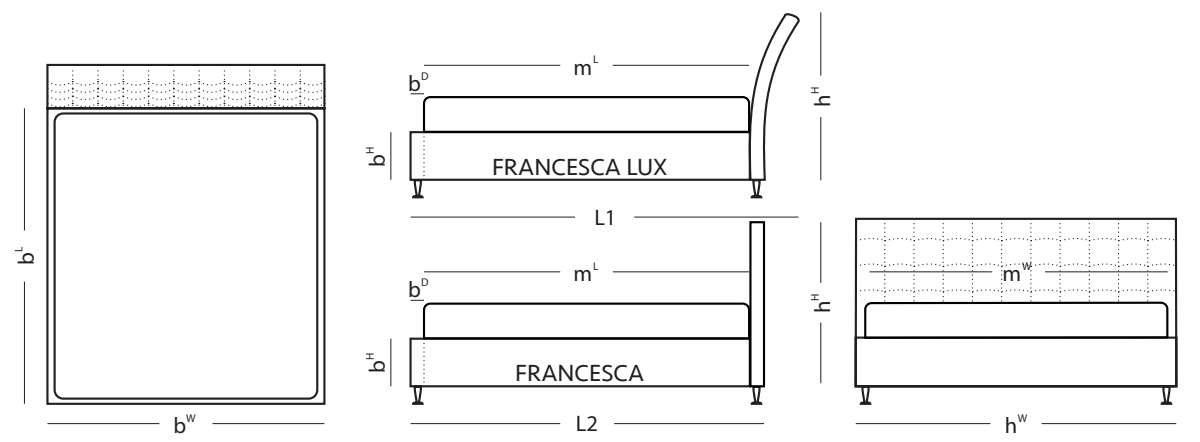
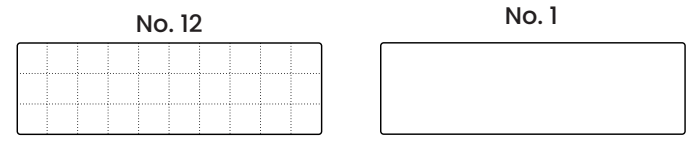



# CLAUDIA LUX

	L1   L2	b <sup>L</sup>	b <sup>W</sup>	b <sup>H</sup>	b <sup>D</sup>	h <sup>W</sup>	h <sup>H</sup>	m <sup>L</sup>	m <sup>W</sup> (cm)
DESIGN BED	234   219	208	196	30	8	196	103	200	180
	234   219	208	176	30	8	176	103	200	160

Taburet  
(p. 125)

No. 16

No. 1

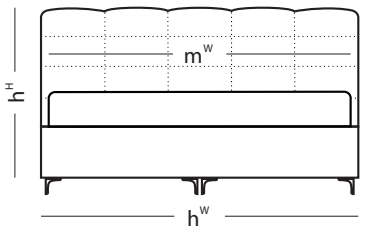
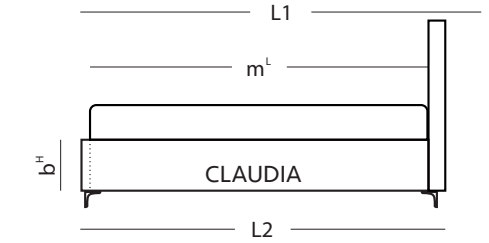
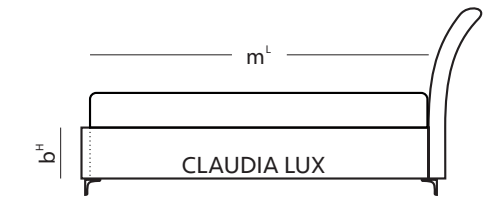
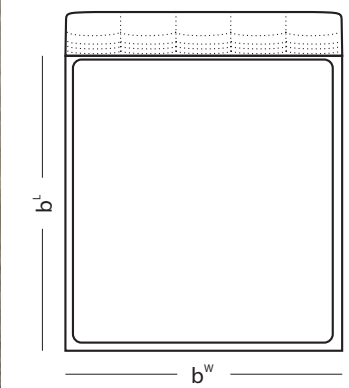



# ALESIA

	L	b <sup>L</sup>	b <sup>W</sup>	b <sup>H</sup>	b <sup>D</sup>	h <sup>W</sup>	h <sup>H</sup>	m <sup>L</sup>	m <sup>W</sup> (cm)
DESIGN BED	217	205	190	30	5	190	103	200	180
	217	205	170	30	5	170	103	200	160

Taburet  
(p. 125)

No. 13



No. 1

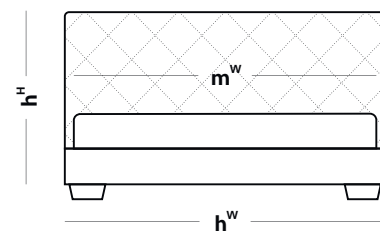
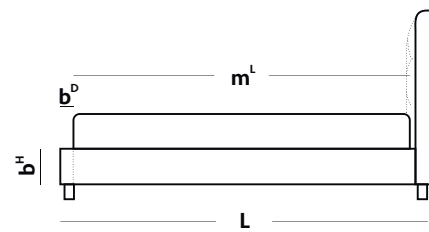
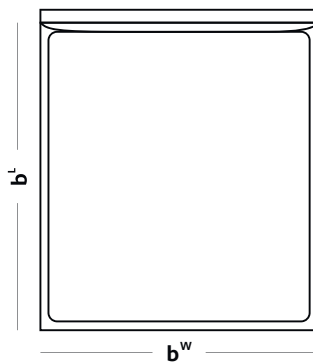





# VEGA

	L	b <sup>L</sup>	b <sup>W</sup>	b <sup>H</sup>	b <sup>D</sup>	h <sup>W</sup>	h <sup>H</sup>	m <sup>L</sup>	m <sup>W</sup> (cm)
DESIGN BED	213	205	190	30	5	190	130	200	180
	213	205	170	30	5	170	130	200	160

Taburet  
(p. 125)

No. 6

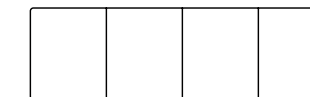

No. 1

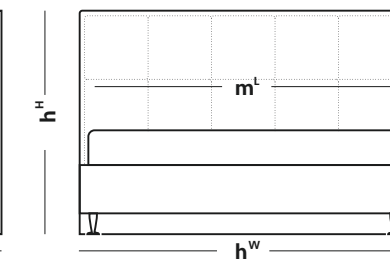
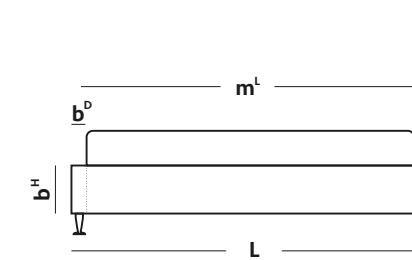
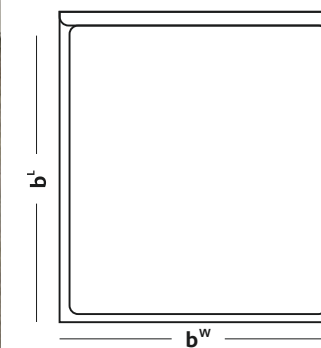





# BELLATRIX

	L	b <sup>L</sup>	b <sup>W</sup>	b <sup>H</sup>	b <sup>D</sup>	h <sup>W</sup>	h <sup>H</sup>	m <sup>L</sup>	m <sup>W</sup> (cm)
DESIGN BED	213	205	190	35	5	190	120	200	180
	213	205	170	35	5	170	120	200	160

Taburet  
(p. 125)

No. 10

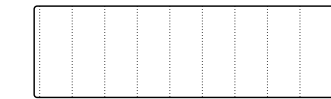

No. 1

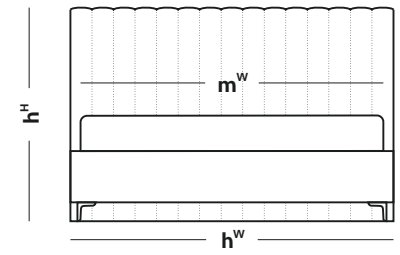
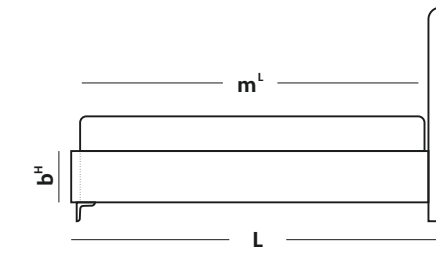
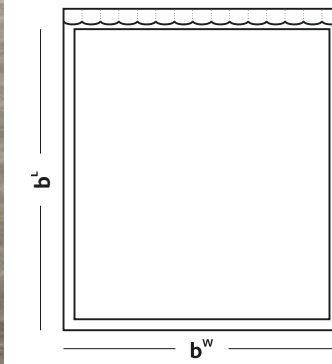



# ATLAS

	L	b <sup>l</sup>	b <sup>w</sup>	b <sup>h</sup>	h <sup>w</sup>	h <sup>h</sup>	m <sup>l</sup>	m <sup>w</sup> (cm)
BOXSPRING 22	225	200	180	22	180	100	200	180
	225	200	160	22	160	100	200	160

Taburet  
(p. 125)

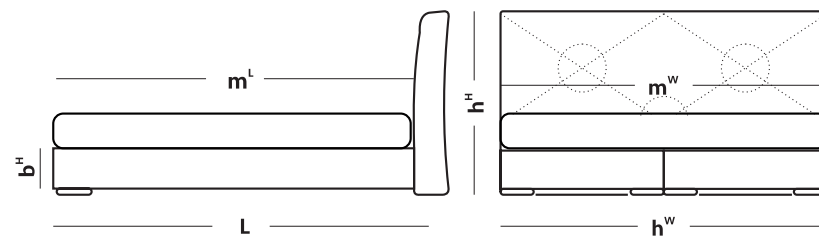
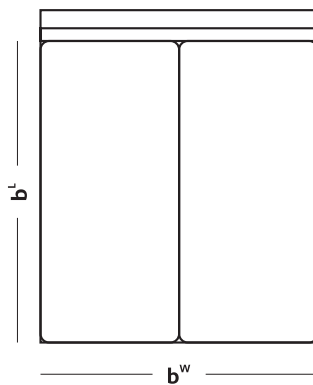
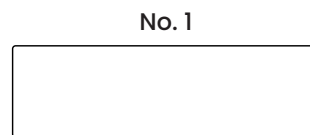
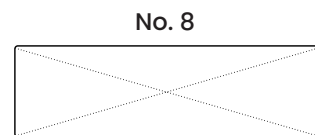



# CORONA

	L	b <sup>l</sup>	b <sup>w</sup>	b <sup>h</sup>	h <sup>w</sup>	h <sup>h</sup>	m <sup>l</sup>	m <sup>w</sup> (cm)
<b>MAXI</b>	208	200	180	32	180	120	200	180
	208	200	160	32	160	120	200	160

Taburet  
(p. 125)

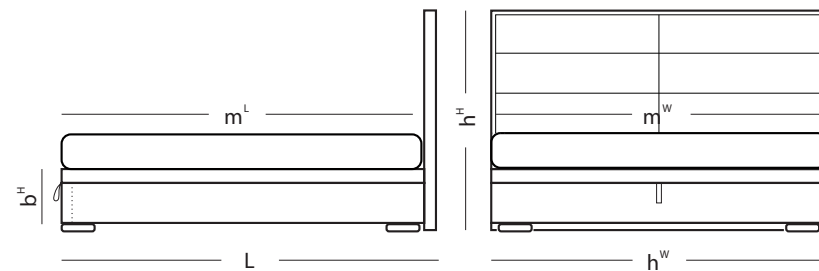
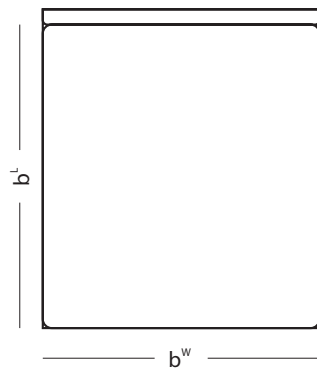
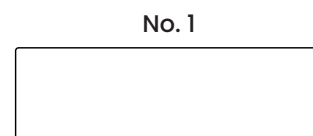
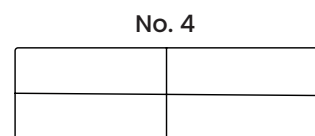

# PARIS

	L	b <sup>L</sup>	b <sup>W</sup>	b <sup>H</sup>	h <sup>W</sup>	h <sup>H</sup>	m <sup>L</sup>	m <sup>W</sup> (cm)
<b>BOXSPRING 32</b>	208	200	180	32	180	197	200	180
<b>+ COVER</b>	208	200	160	32	160	197	200	160

Taburet  
(p. 125)

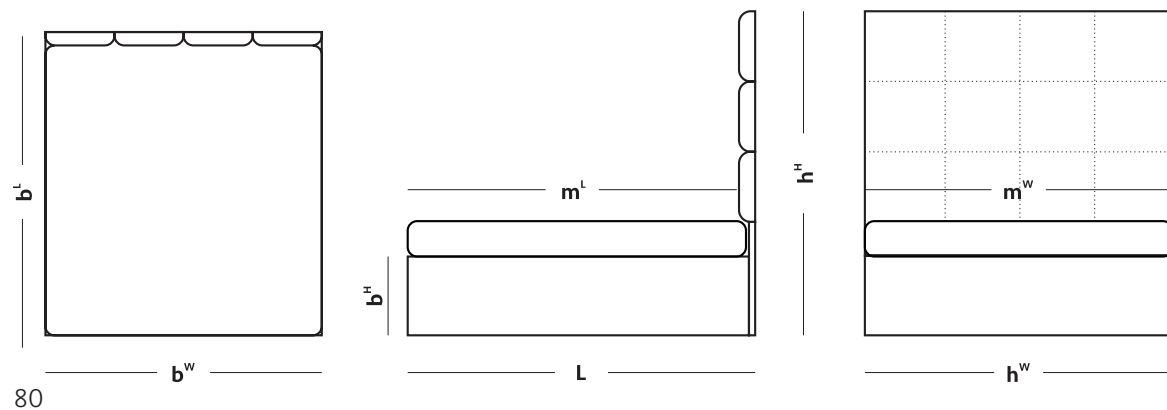
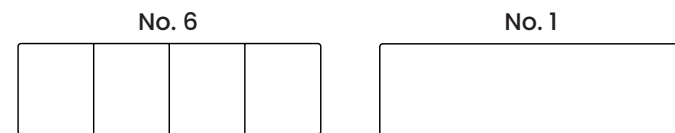



# VIENNA

	L	b <sup>L</sup>	b <sup>W</sup>	b <sup>H</sup>	h <sup>W</sup>	h <sup>H</sup>	m <sup>L</sup>	m <sup>W</sup> (cm)
BOXSPRING 32	208	200	180	32	190	160	200	180
	208	200	160	32	170	160	200	160

Taburet  
(p. 125)

No. 15

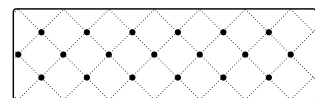

No. 1

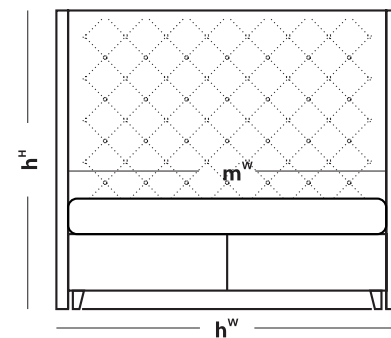
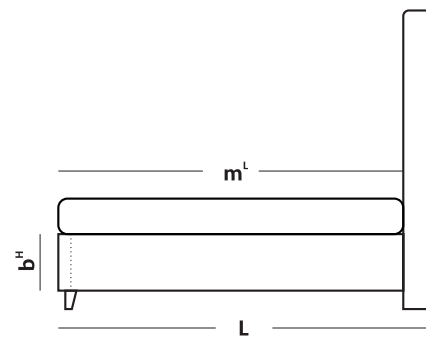
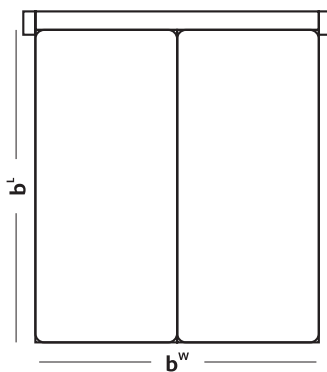

# NOBILIA

	L	b <sup>L</sup>	b <sup>W</sup>	b <sup>H</sup>	b <sup>D</sup>	h <sup>W</sup>	h <sup>H</sup>	m <sup>L</sup>	m <sup>W</sup> (cm)
DESIGN BED	213	205	190	30	5	190	120	200	180
	213	205	170	30	5	170	120	200	160

Taburet  
(p. 125)

No. 9



No. 1

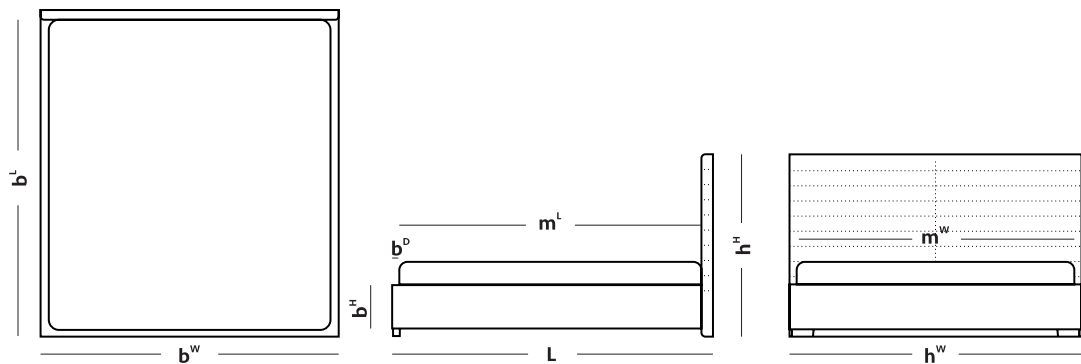





# ARGENTINA

	L	b <sup>L</sup>	b <sup>W</sup>	b <sup>H</sup>	b <sup>D</sup>	h <sup>W</sup>	h <sup>H</sup>	m <sup>L</sup>	m <sup>W</sup> (cm)
DESIGN BED	213	205	190	35	5	190	120	200	180
	213	205	170	35	5	170	120	200	160

Taburet  
(p. 125)

No. 1

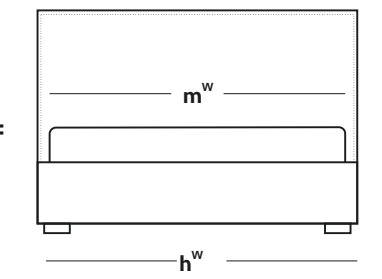
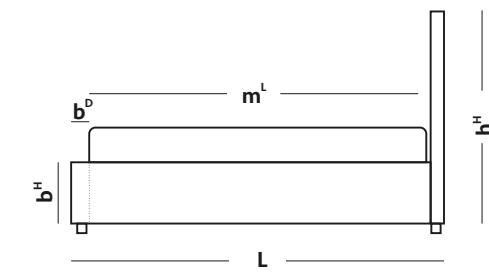
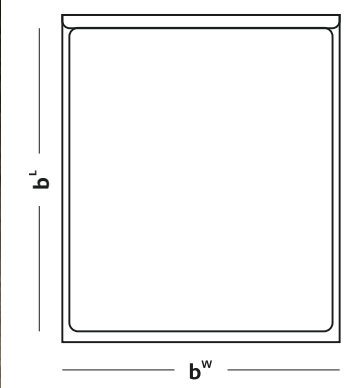



# SIRIUS

	L	b <sup>L</sup>	b <sup>W</sup>	b <sup>H</sup>	h <sup>W</sup>	h <sup>H</sup>	m <sup>L</sup>	m <sup>W</sup> (cm)
<b>BOXSPRING MOBIL</b>	208	200	180	32	180	120	200	180
	208	200	160	32	160	120	200	160

Taburet  
(p. 125)

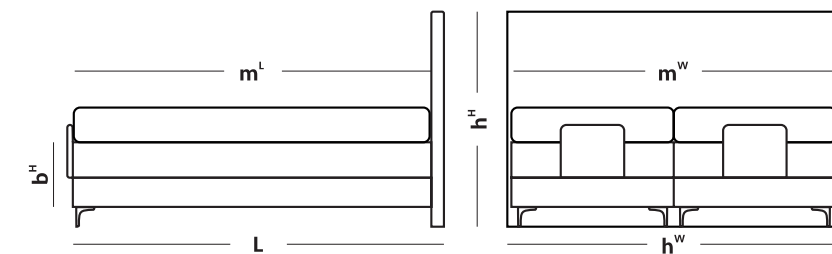
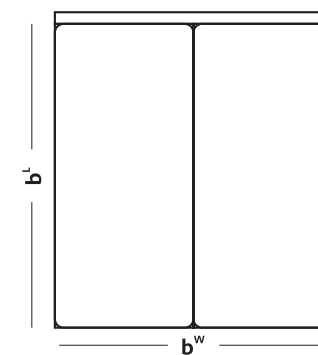
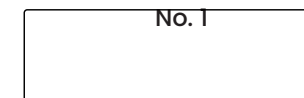





# VELORUM

	L	b <sup>L</sup>	b <sup>W</sup>	b <sup>H</sup>	h <sup>W</sup>	h <sup>H</sup>	m <sup>L</sup>	m <sup>W</sup> (cm)
<b>BOXSPRING 32</b>	208	200	180	32	180	120	200	180
	208	200	160	32	160	120	200	160

Taburet  
(p. 125)

No. 14

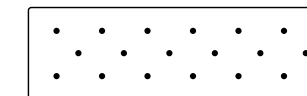

No. 1

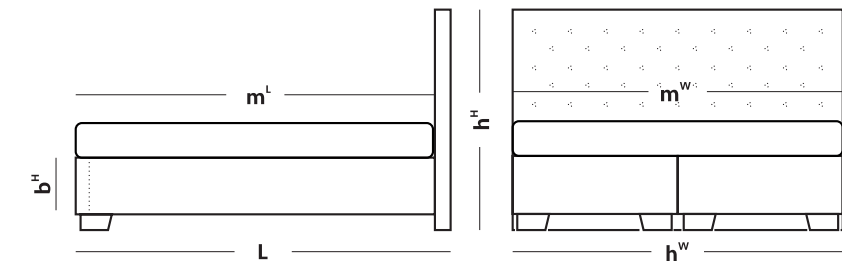
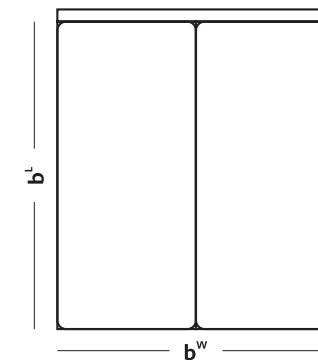



# CORIUM SLIDE

NEW

	L	b <sup>L</sup>	b <sup>W</sup>	b <sup>H</sup>	h <sup>W</sup>	h <sup>H</sup>	m <sup>L</sup>	m <sup>W</sup> (cm)
<b>BOXSPRING</b>	210	200	95	46	105	120	200	95
<b>Slide</b>							185	90

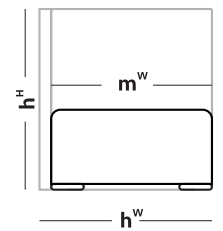
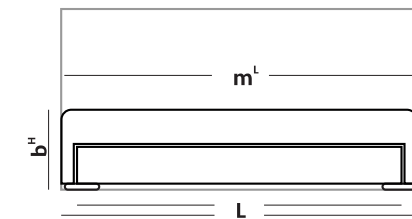
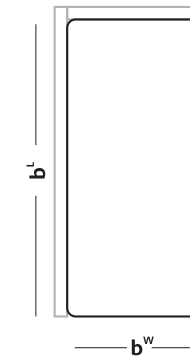





# WALL

NEW

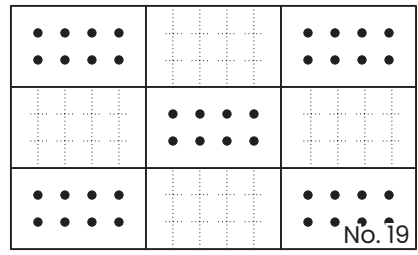
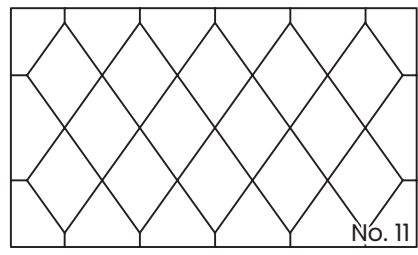
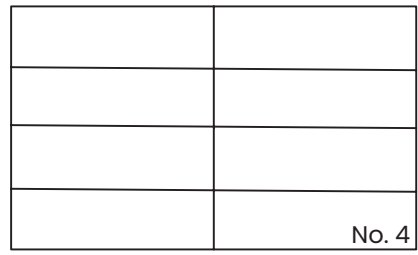
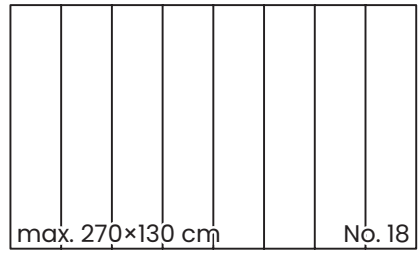
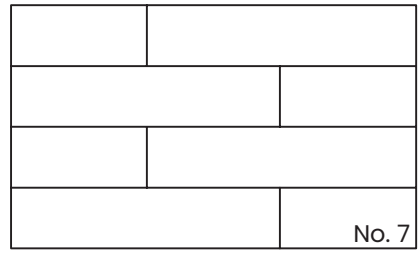
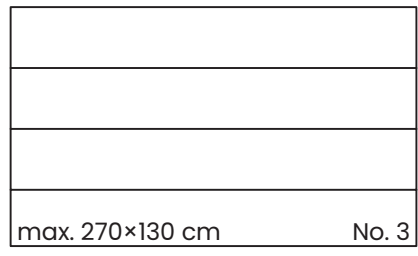
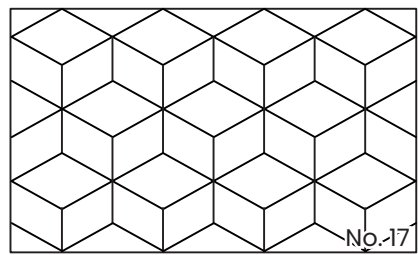
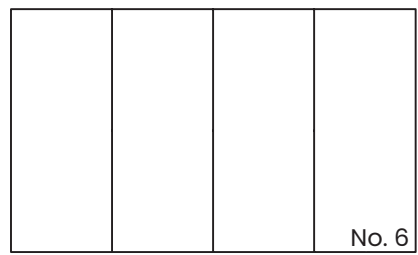
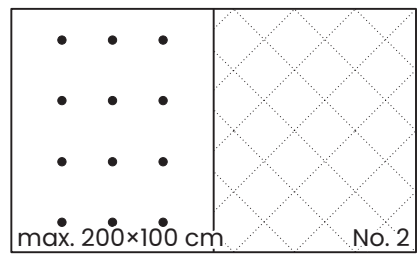



# TWINS

NEW

L	b <sup>w</sup>	b <sup>H</sup>	b <sup>H1</sup>	b <sup>H2</sup>	m <sup>L</sup>	m <sup>w</sup> (cm)
224	100	197	30	154	200	90

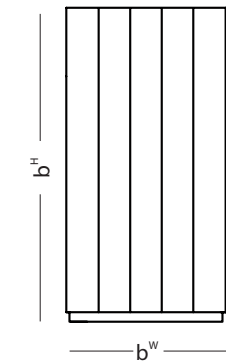
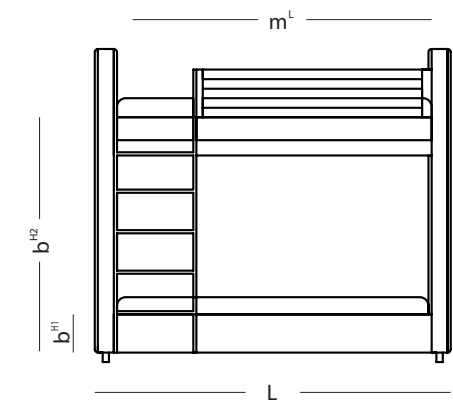
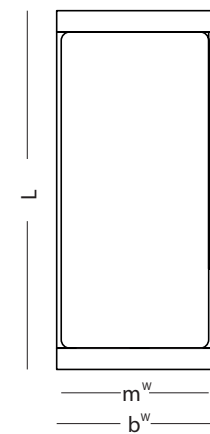



NEW



# AMIRA

L	b	h	L <sup>r</sup>	h <sup>r</sup>	L <sup>w</sup>	h <sup>w</sup> (cm)
200	80/90	22 - 45	70	23	80/90	28

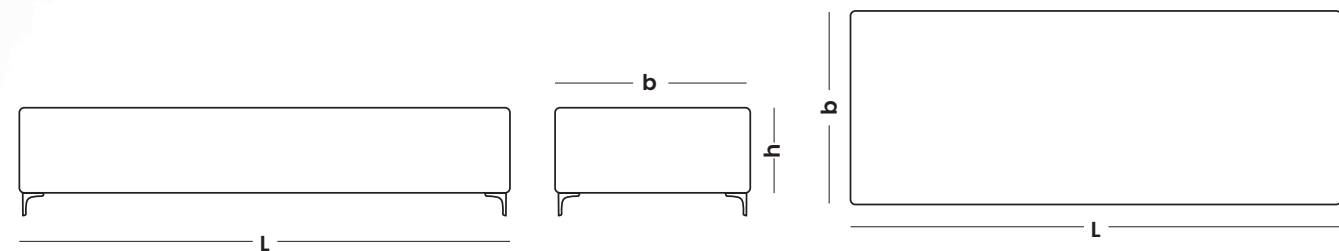
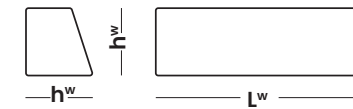
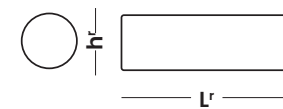

NEW



# SIESTA

a	b	c	d	e	f	g	h	L (cm)
80	88	40	75	14	5	60	86	188

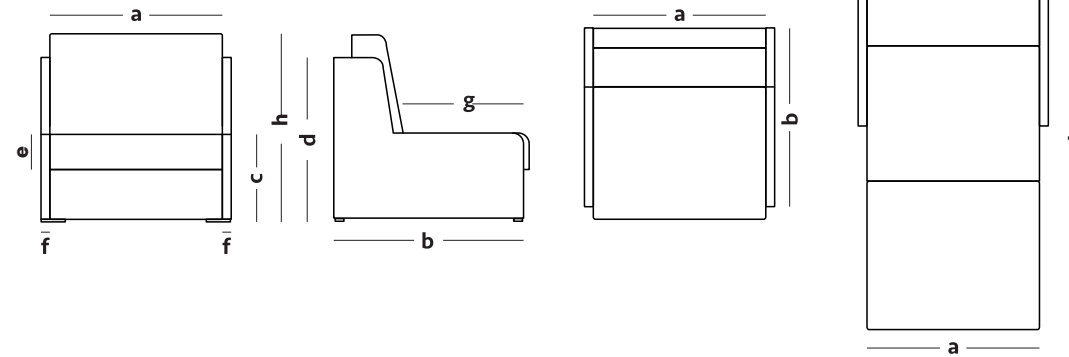



NEW



# SOFABED BARI

	a	b	c	d	e	f	g	m <sup>l</sup>	m <sup>w</sup>	L (cm)
<b>BARI DOUBLE</b>	210	49	68	100	62	30	152	190	140	240
<b>BARI TRIPLE</b>	230	49	68	100	62	30	172	190	160	240

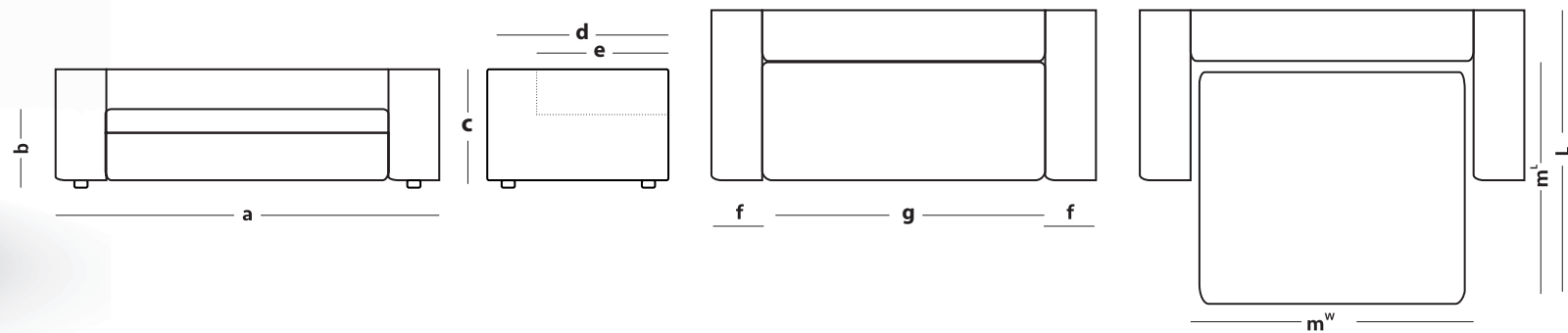

NEW



# SOFABED TORVI

	a	b	c	d	e	f	g	h	m <sup>l</sup>	m <sup>w</sup>	L (cm)
SOFABED DOUBLE	163	93	55	56	183	10	60	96	190	140	215
SOFABED TRIPLE	183	93	55	56	203	10	60	96	190	160	215

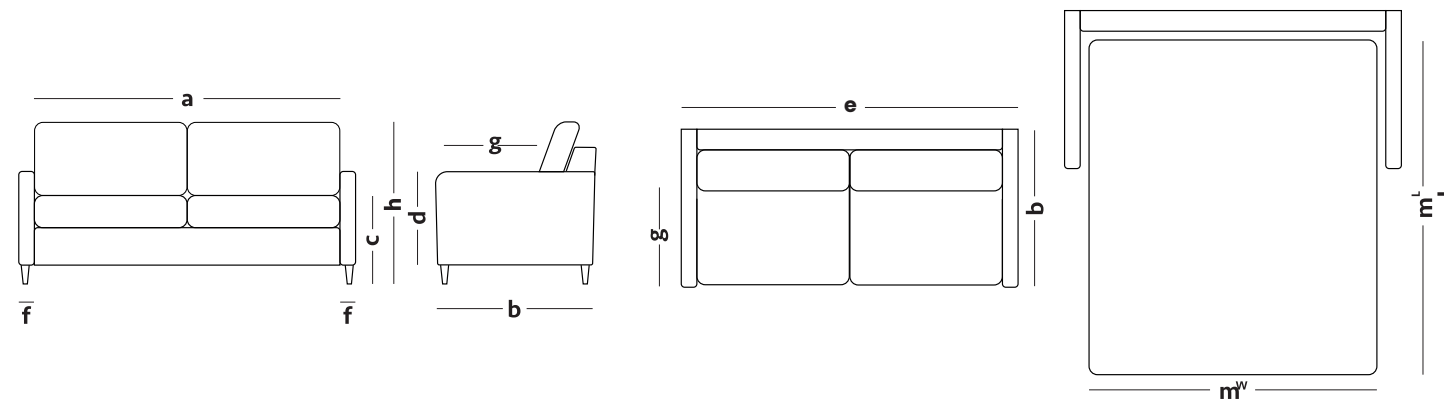





# SOFABED SINGLE

a	b	c	d	f	g	h	m <sup>l</sup>	m <sup>w</sup>	L	(cm)
80	98	48	60	13 17 21	55	85	190	80	215	

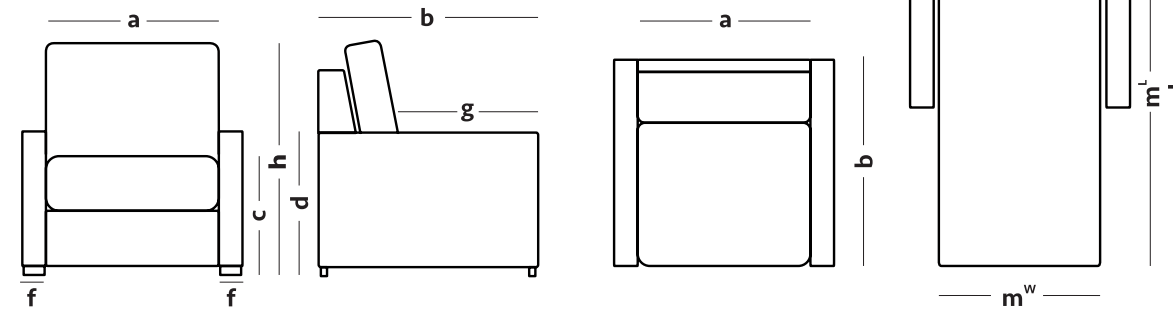



# SOFABED DOUBLE

	a	b	c	d	f	g	h	m <sup>l</sup>	m <sup>w</sup>	L (cm)
SOFABED DOUBLE	163	98	48	60	13 17 21	55	85	190	140	215
SOFABED TRIPLE	183	98	48	60	13 17 21	55	85	190	160	215

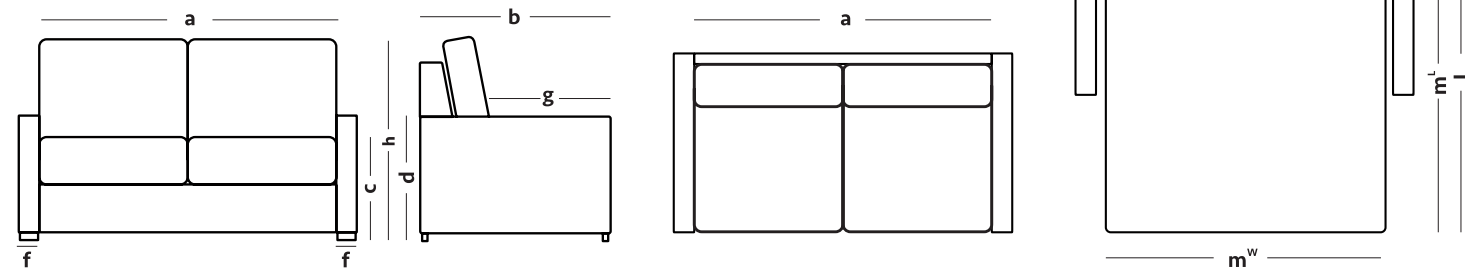



# BOUDOIR MONT BLANC

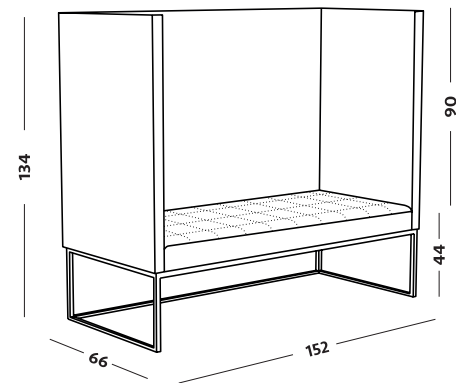

# MONT BLANC

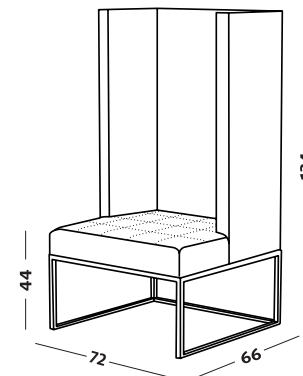

NEW

# BOSS



a	b	c	d	e	f	g	h	i	(cm)
50	50	105	95	50	50	78	95	30	

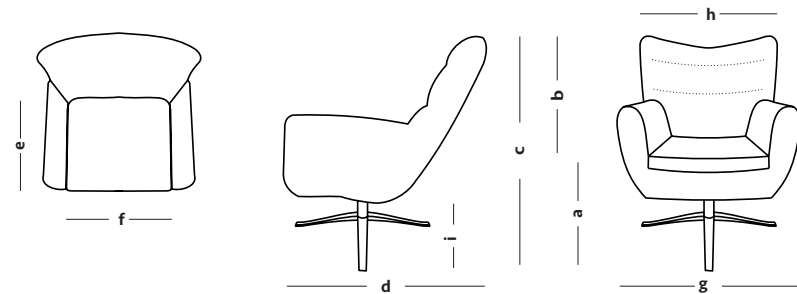

# MOON



a	b	c	d	(cm)
93	90	45	63	

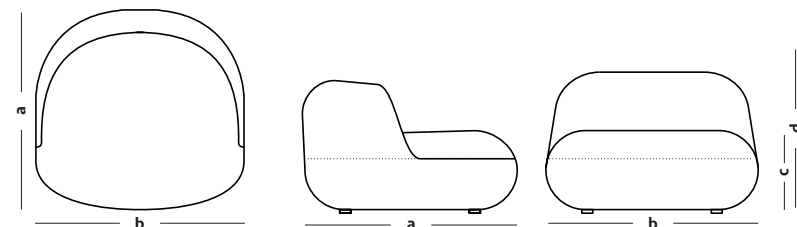



# PUFF

NEW

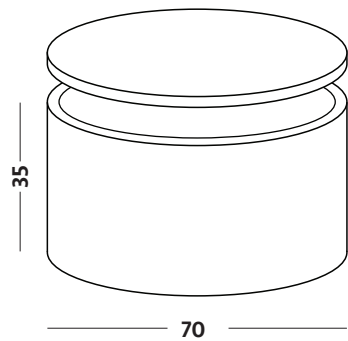

NAEL

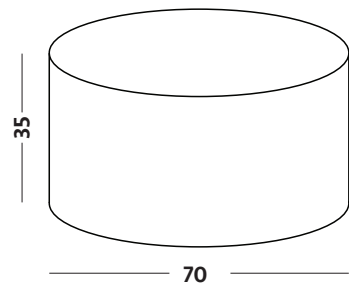

MONI

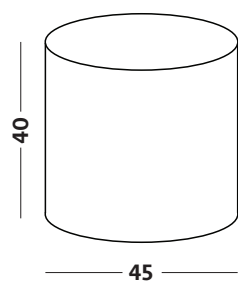

OLI

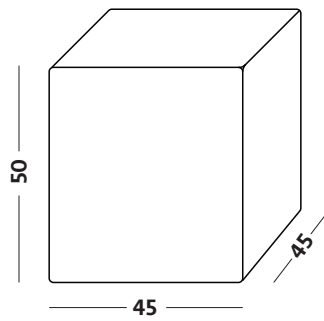

TINA

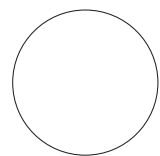

No. 1

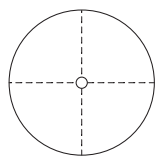

No. 2

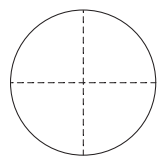

No. 3

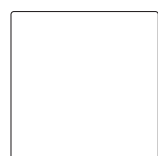

No. 1

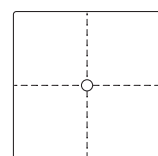

No. 2

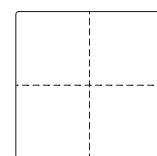

No. 3



NEW



# BOUDOIR BREEZE

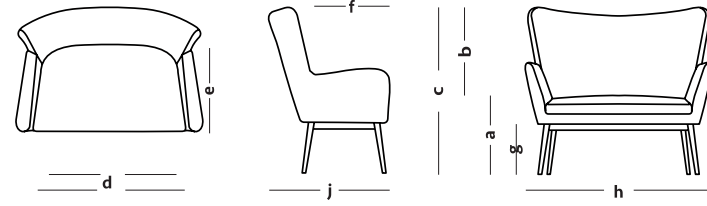

	a	b	c	d	e	f	g	h	j	(cm)
<b>CROSS</b>	45	53	98	116 100	56	54	31	140	84	

# BREEZE

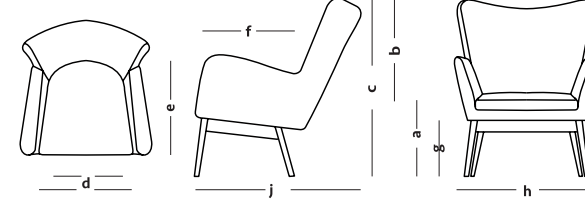

	a	b	c	d	e	f	g	h	j	(cm)
<b>CUT</b>	45	63	94	56 42	56	42	26 31	78	85	
<b>CROSS</b>	45	63	102	56 42	56	42	32	78	80	

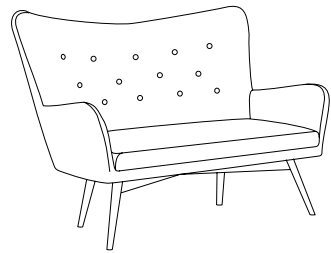

Button

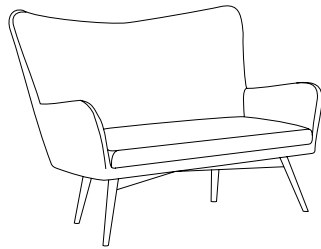

Clean

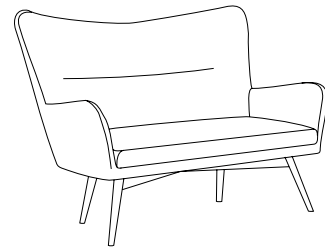

Mirach

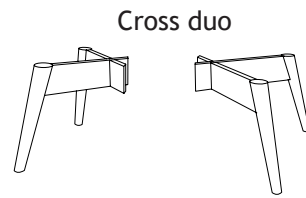

Cross duo

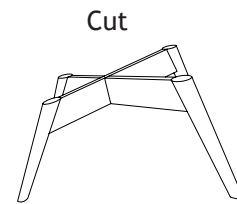

Cut

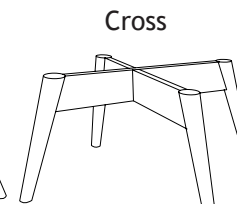

Cross

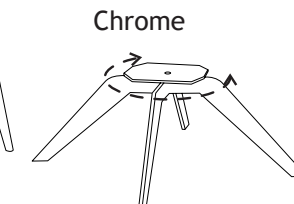

Chrome

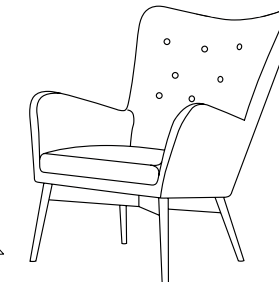

Button

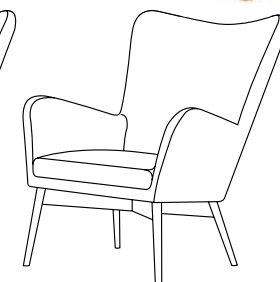

Clean

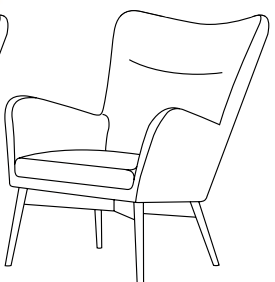

Mirach





# DE LUXE

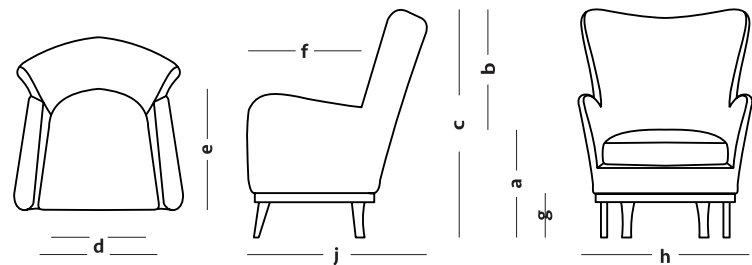

	a	b	c	d	e	f	g	h	j	(cm)
<b>CASTEL</b>	45	55	100	56   42	54	49	20	79	80	
<b>LINE</b>	46	55	101	56   42	54	49	21	79	80	

# MODERN

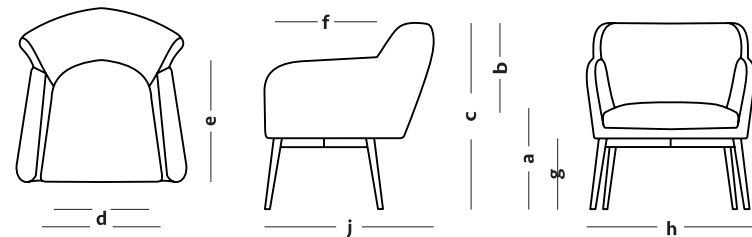

	a	b	c	d	e	f	g	h	j	(cm)
<b>CUT</b>	45	33	69	55   44	56	42	26   31	75	79	
<b>CROSS</b>	45	33	78	55   44	56	42	32	75	75	

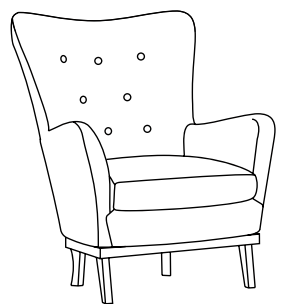

Button

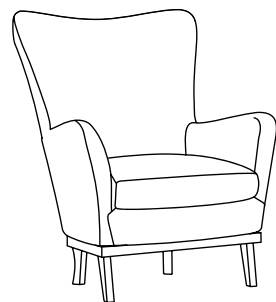

Clean

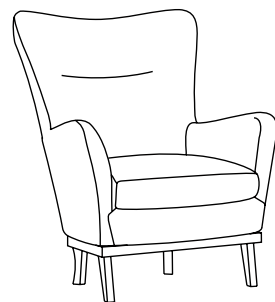

Mirach

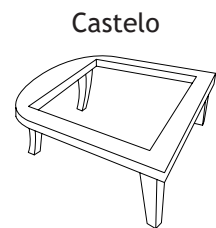

Castelo

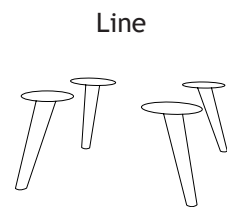

Line

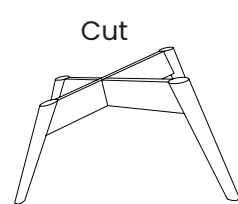

Cut

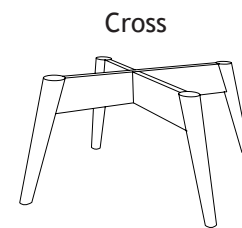

Cross

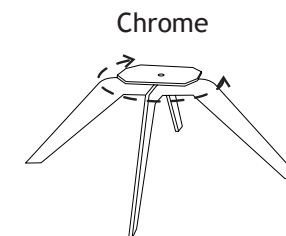

Chrome

CUT

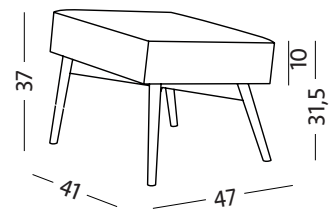

CASTELO

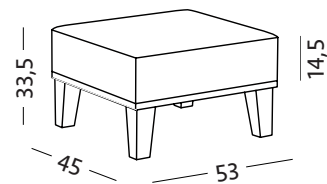

CROSS

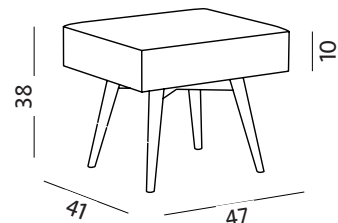

INDUSTRY

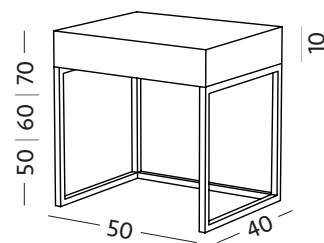

HEAVY OAK

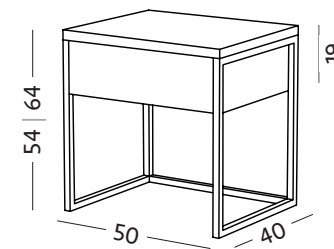

OAK

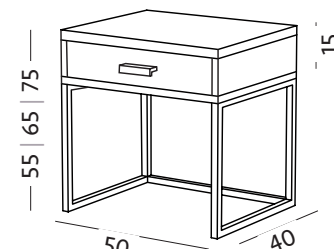



WHITE

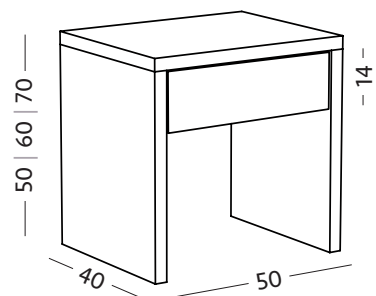

STONE

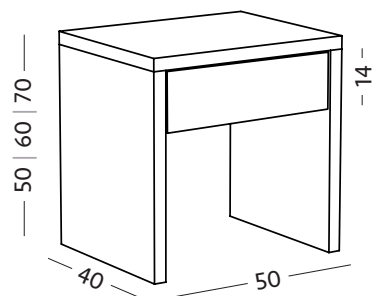

DARK STONE

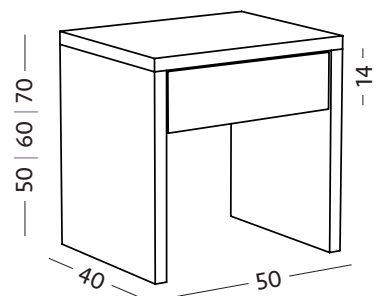

CUBE

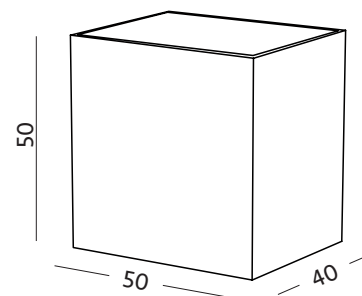

DAMIANI

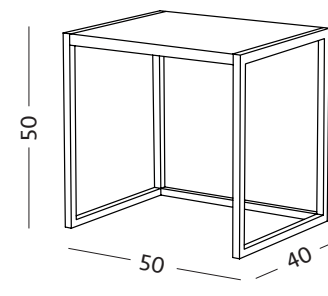

BIANCA

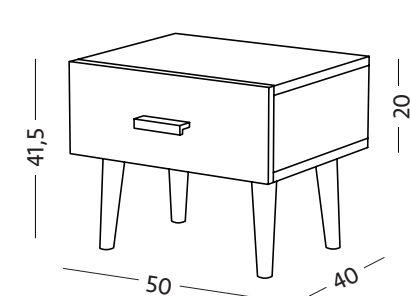

# TABURET | BENCH

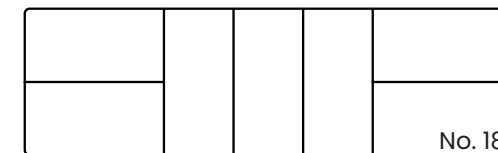
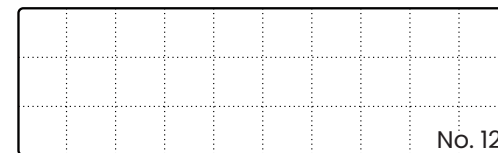
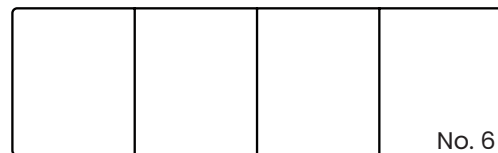
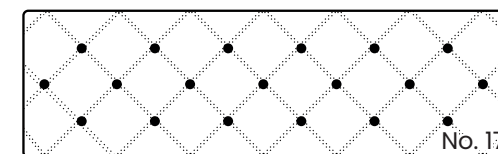
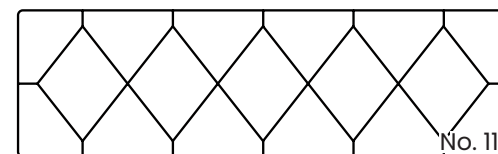
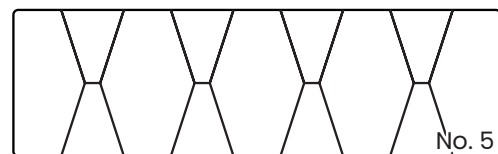
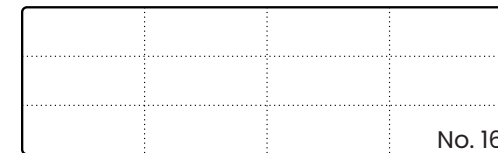
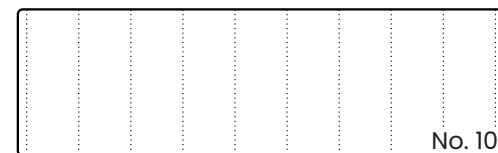
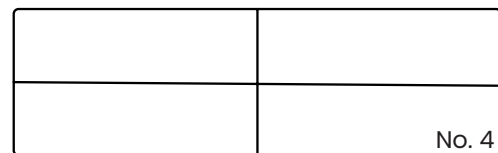
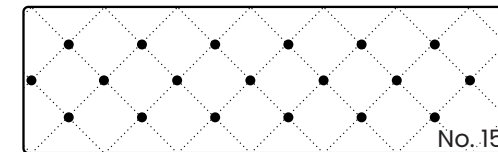
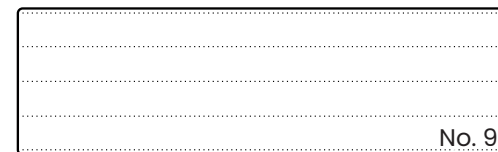
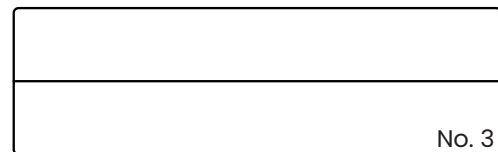
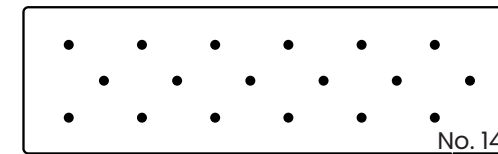
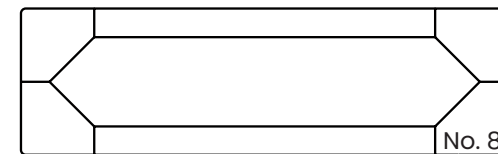
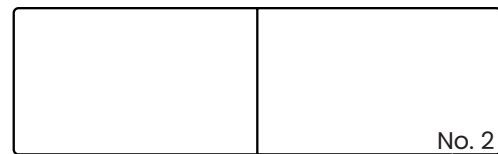
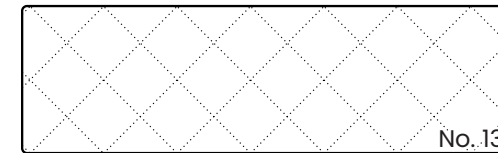
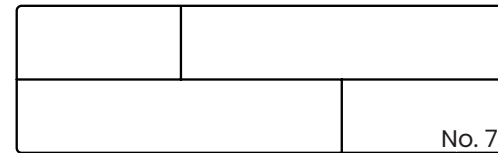
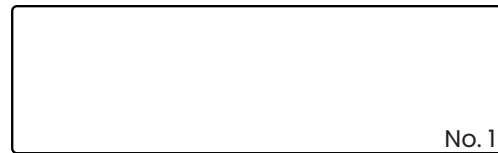
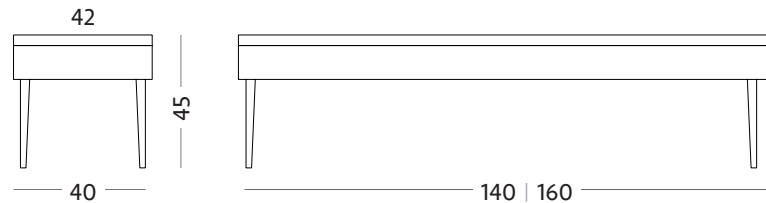
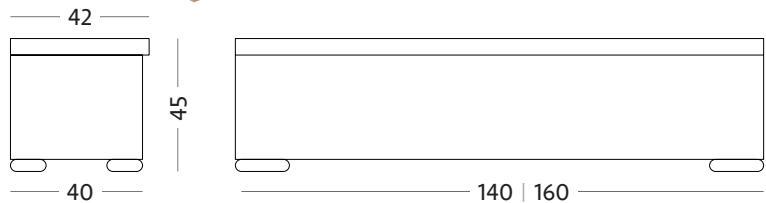



NEW



Flute

120 | 150 | 190 mm - black, bronze, chrome, gold

NEW



Line

120 | 150 | 220 mm - chrome, black, white

NEW



Light

150 mm - black

NEW



Floor angle

200×200×20 mm - chrome

NEW



Floor tube

200 mm × 32 mm - chrome



Floor

150×150×30 mm - chrome

NEW



Capri

200 mm - black | 190 mm - chrome

NEW



Dual

150 mm - black

NEW



Spider

120 | 150 mm - chrome

NEW



Fancy

130 mm - chrome



Industry

130 mm - black

NEW



Elegance

130 mm - black, white, chrome, gold



Polygon

100 mm - chrome



Metal

80 mm - chrome

NEW



**Block ·**

100 | 130 | 160 mm – natur, walnut, gray, wenge, black



**Wood 1**

88 | 100 | 130 mm – natur, gray, walnut, wenge, black



**Tulip**

130 mm – natur



**Castello**

130 mm – walnut



**Cube**

100 mm – cherry



**Wood 2**

80 mm – natur, walnut, gray, wenge, black



**Wood 4**

110 mm – natur, walnut, gray, wenge, black



**Wood 5**

110 mm – natur, walnut, gray, wenge, black

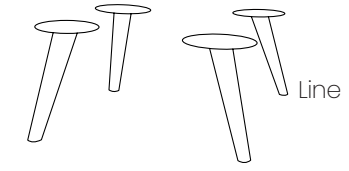

Line

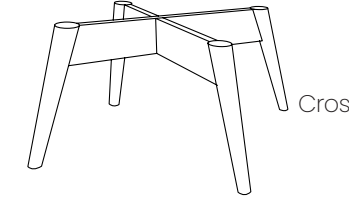

Cross

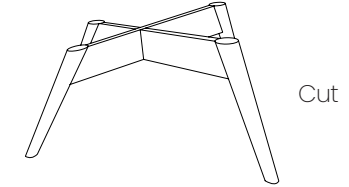

Cut

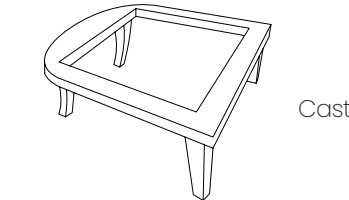

Castello

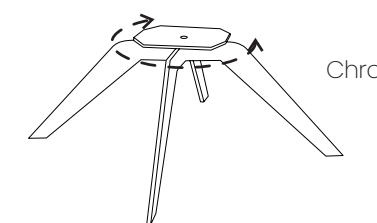

Chrome



Natur



White



Walnut



Wenge





- SK** Obsah katalógu je duševným vlastníctvom firmy Materasso Slovakia s. r. o. Použit' tieto materiály je možné len s uvedením ich vlastníka: © Materasso Slovakia s. r. o. Nedodržanie týchto podmienok je právne **vymáhateľné ako porušenie autorských práv**. Farby použitých materiálov sú ilustračné, môžu byť odlišné od skutočnosti.
- CZ** Obsah katalogu je duševním vlastnictvím firmy Materasso Slovakia s. r. o. Použit' tyto materiály lze pouze s uvedením jejich vlastníka: © Materasso Slovakia s. r. o. Nedodržení těchto podmínek je právně **vymáhateľné jako porušení autorských práv**. Barvy použitých materiálů jsou ilustrační, mohou být odlišné od skutečnosti.
- EN** The content of the catalogue is the intellectual property of Materasso Slovakia s. r. o. It is possible to use these materials only with the indication of their owner: © Materasso Slovakia s. r. o. Failure to comply with these terms and conditions is legally **enforceable as copyright infringement**. The colors of the materials used are illustrative, they may differ from the actual ones.
- PL** Zawartość katalogu jest własnością intelektualną Materasso Slovakia s. r. o. Korzystanie z tych materiałów jest możliwe tylko za wskazaniem ich właściciela: © Materasso Slovakia s. r. o. Nieprzestrzeganie tych warunków jest prawnie **egzekwowalne jako naruszenie praw autorskich**. Kolory użytych materiałów mają charakter poglądowy, mogą różnić się od rzeczywistych.
- HU** A katalógus tartalma a Materasso Slovakia s. r. o. szellemi tulajdonát képezi. Ezeket az anyagokat csak a tulajdonos feltüntetésével lehet felhasználni: © Materasso Slovakia s. r. o. E feltételek be nem tartása jogilag **érvényesíthető szerzői jogsértésként**. A felhasznált anyagok színei illusztrációs célokat szolgálnak, és eltérhetnek a valóságtól.
- DE** Der Inhalt des Katalogs ist geistiges Eigentum von Materasso Slovakia s. r. o. Die Nutzung dieser Materialien ist nur mit Angabe des Eigentümers möglich: © Materasso Slovakia s. r. o. Die Nichteinhaltung dieser Bestimmungen und Bedingungen kann als **Urheberrechtsverletzung rechtlich verfolgt werden**. Die Farben der verwendeten Materialien sind illustrativ, sie können von den tatsächlichen abweichen.

m  
Materasso  
[www.materasso.cz](http://www.materasso.cz)  
2025

